

# LAY-Z-SPA<sup>®</sup>

2024



Bestway<sup>®</sup>

# Bestway

## 2024 CATALOG COLLECTION

Enjoy our extensive collection of products in our six catalogs.

- Above Ground Pools
- Air Mattresses
- Lay-Z-Spa
- Summer & License
- Watersports
- Camping Gear\*  
Only available for INTL

### Digital Catalogs

Easily access all of our catalogs while on the go. Ask your Sales Rep for the link to our catalog website, and Bestway® products can be right at your fingertips!

- View the latest catalogs
- Quickly flip through and find any product
- Check out product details, photos and even videos

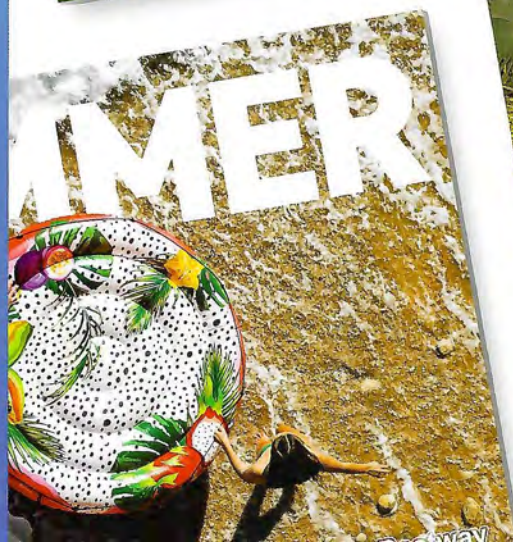



# SUMMER

2024

Bestway

# ABOVE GROUND POOLS

2024

Bestway Steel Pro MAX

Bestway



# Y-Z-SPA

Bestway

# WATER SPORTS

2024

Bestway

# CAMPING

2024

# CAMPING

# AIR MATTRESS

2024





## VISION & MISSION

Since 1994, our vision has been to create fun, memorable experiences for everyone in the world through our innovative, dependable products.

Now, just over 25 years later, **Bestway** has forged a global presence in more than 100 countries by developing an extensive product line and becoming forward thinkers about sustainable business practices. Today, we manufacture and sell more than 1,100 different products within four core categories: above ground pools and portable spas, recreational products, sporting goods, and camping products.

## SERVICE

**Bestway** is committed to customer satisfaction and providing you with the best product solutions. That's why every department in Bestway works closely together - from our technology and quality assurance centers to our laboratories, vertically integrated manufacturing systems and after-sales service centers around the globe.

**Bestway's** advanced online services and regional call centers allow customers to easily resolve issues that arise with their products, offering downloadable manuals, instructional videos, and 24/7 call support.



VERTICALLY INTEGRATED



CUSTOMER FOCUSED



INNOVATIVE



SUSTAINABLE



CONSUMER DRIVEN



FULLY OWNED PRODUCTION FACILITIES



SERVICE & SOLUTIONS

# GLOBAL FACTORIES



JIANGSU



YANCHENG



HAIAN



NANTONG



SHANGHAI



VIETNAM

# AROUND THE WORLD



CHANDLER, U.S.A.  
R&D • SUBSIDIARY



SANTIAGO, CHILE  
SUBSIDIARY



SAN PAULO, BRAZIL  
SUBSIDIARY



HAMBURG, GERMANY  
SUBSIDIARY



NICE, FRANCE  
SUBSIDIARY



MILAN, ITALY  
R&D • SUBSIDIARY



COPENHAGEN, DENMARK  
SUBSIDIARY



WARSAW, POLAND  
SUBSIDIARY



DUBAI, U.A.E.  
SUBSIDIARY



MOSCOW, RUSSIA  
SUBSIDIARY



HONG KONG, CHINA  
R&D • SUBSIDIARY



SHANGHAI, CHINA  
HQ • PRODUCTION



SYDNEY, AUSTRALIA  
SUBSIDIARY



# WELCOME

Almost a decade of advanced engineering innovations have built a name that people all around the world have grown to trust.

Lay-Z-Spa® offers an affordable spa experience that's convenient to use, easy to set up and offers total relaxation.

Backed by the Bestway® customer service team, consumers can enjoy peace of mind while relaxing in their brand new spa.

With different massage technologies, a Lay-Z-Spa offers the ultimate way to rest and recharge.



# CONTENTS

## AIRJET™

ST. LUCIA  
60037  
pg 26-29

MIAMI  
60001  
pg 30-33

BAHAMAS  
SIGNATURE  
60005  
pg 34-37

FIJI  
SIGNATURE  
60085  
pg 38-41

HAVANA  
SMART  
60035  
pg 42-45

BORACAY  
SMART  
60175  
pg 46-49

IBIZA  
60015  
pg 50-53

HOLLYWOOD  
LUXE  
60059  
pg 54-57

HAWAII  
SMART  
60261  
pg 58-61

ZURICH  
ENERGYSENSE™  
60065  
pg 62-65

BUDAPEST  
ENERGYSENSE™  
60179  
pg 66-69

HONOLULU  
SMART  
60019  
pg 70-73

HAWAII  
SMART  
60021  
pg 74-77

ST. MORITZ  
SMART  
60023  
pg 78-81

GRENADA  
SMART  
60135  
pg 82-85

## AIRJET PLUS™

MILAN  
SMART  
60029  
pg 88-91

HELSINKI  
SMART  
60025  
pg 92-95

## HYDROJET PRO™

SANTORINI  
SMART  
60075  
pg 98-101

MALDIVES  
SMART  
60033  
pg 102-105

SAN FRANCISCO  
SMART  
60161  
pg 106-109

## XTRAS

UNDERWATER  
VACUUM  
60323 | pg 112

RECHARGEABLE  
UNDERWATER  
VACUUM  
60327 | pg 113

PILLOW  
60307 | pg 114

PADDED  
PILLOW  
60316 | pg 114

SPA SEAT  
60321 | pg 115

SOOTHING LED  
WATERFALL  
60322 | pg 116

DRINK HOLDER  
60306 | pg 117

7-COLOR LED  
LIGHT  
60303 | pg 117

DOME  
60305 | pg 118

CANOPY  
60304 | pg 119

FLOOR  
PROTECTOR  
60334 | pg 119

ALL IN ONE  
TOOL SET  
60310 | pg 120

FILTER  
CARTRIDGE (VI)  
60311 | pg 121

POOL & SPA  
TEST STRIPS  
58142 | pg 121



# PRODUCT TECHNOLOGY



## THE ORIGINAL PREMIUM PORTABLE SPA™

As a leading manufacturer of the inflatable, portable hot tub, Lay-Z-Spa® has become an industry staple that consumers know and trust. From technological innovations to style, Lay-Z-Spa leads the market. High-functioning components and safety are the main priorities of the spa line, providing consumers with products they can depend on.



## FREEZE SHIELD™ TECHNOLOGY

### COMFORT IN THE COLD

Freeze Shield™ successfully equips the spa for year-round, all-weather use. Designed with innovative winterizing technology and an improved material, these spas automatically increase water circulation and heating when temperatures are low to prevent the inner parts from damage.



## THERMAL INSULATION

### HIGH ENERGY-EFFICIENCY, LOW ELECTRIC BILL

The EnergySense™ thermal covers and liners retain more heat than PVC material alone. This allows the spa to heat up faster and stay hotter longer, leading to as much as 40% higher energy-efficiency.





## HIGH-TECH COMPONENTS AND DECREASED NOISE

EFFICIENT • DURABLE • SAFE

The internal pump components are designed to work efficiently, while reducing the noise level as much as possible during use. Engineered with a rotor and blade, our pumps are specifically designed to have a soft internal connection, reducing the noise.

## ADVANCED HEATING SYSTEM

By using advanced materials to create our heating mechanism, including aluminum alloys and ceramic, we ensure efficient temperature control. The internal structure is protected by six layers of insulation to prevent electrical damage, ensuring safe use every time.





LAY-Z-SPA.  
HAWAII

# PRODUCT SAFETY

Safety is our top priority when designing and producing our inflatable spas. We are consistently upgrading our products to ensure that consumer safety is never compromised. Currently, Lay-Z-Spa is the only brand on the market that uses this exclusive GDS & GLEDS technology.

## GDS

### GROUND DETECTION SYSTEM

With safety as a priority, every spa is equipped with our advanced, marketleading Ground Detection System, which monitors the energy supply to ensure it is being used safely. If the system detects an issue, the pump alerts the user and does not allow further use until the power supply is correctly earthed.

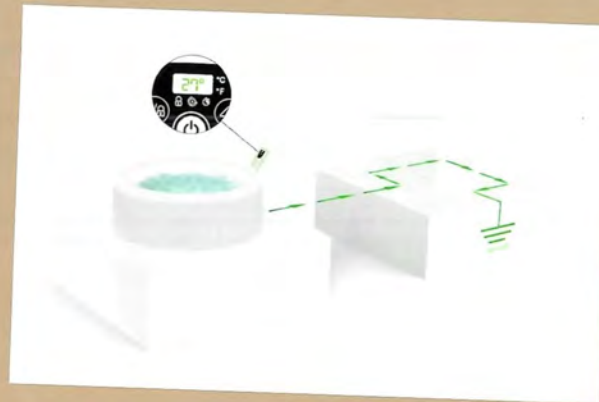

## GLEDS

### GROUND LINE ELECTRIC DETECTION SYSTEM

Once the spa is plugged in, the system continuously monitor the ground of the electrical system in the house and will advise the user with the E18 code if conditions are unsafe.

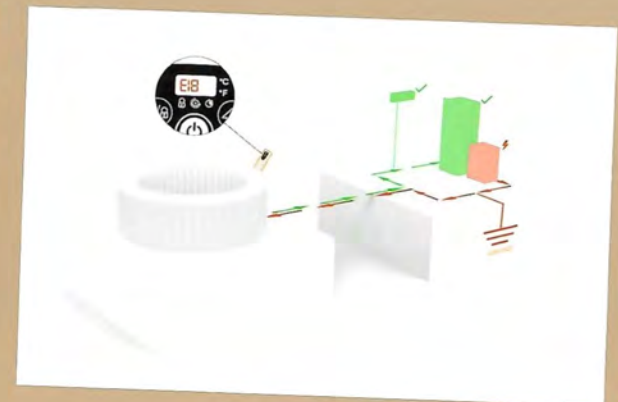
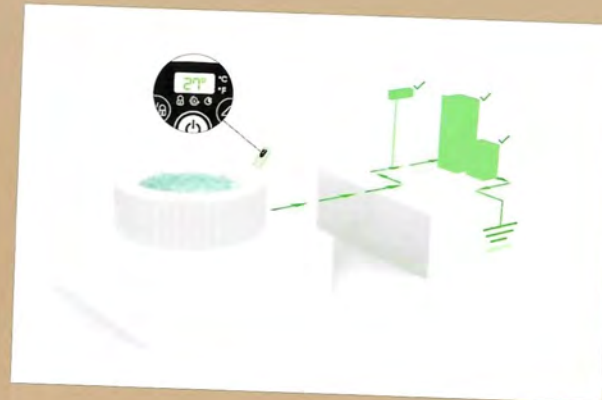

# MASSAGE TECHNOLOGY



## AIRJET™ SYSTEM

Soothe your body and relax your mind with the touch of a button! The AirJets work by releasing warm air into the water, surrounding you with a calming bubble massage.



## AIRJET PLUS™ SYSTEM

Enjoy a deeper massage with AirJet Plus! Air bubbles are released from both the perimeter and center of the bottom of the spa to target both the legs and back.



## HYDROJET PRO™ SYSTEM

HydroJet Pro is the best of both worlds! Adjustable nozzles along the inside walls of the spa release soothing jetstreams of water, while jets along the bottom release a calming flow of air bubbles specifically targeting your feet and back.

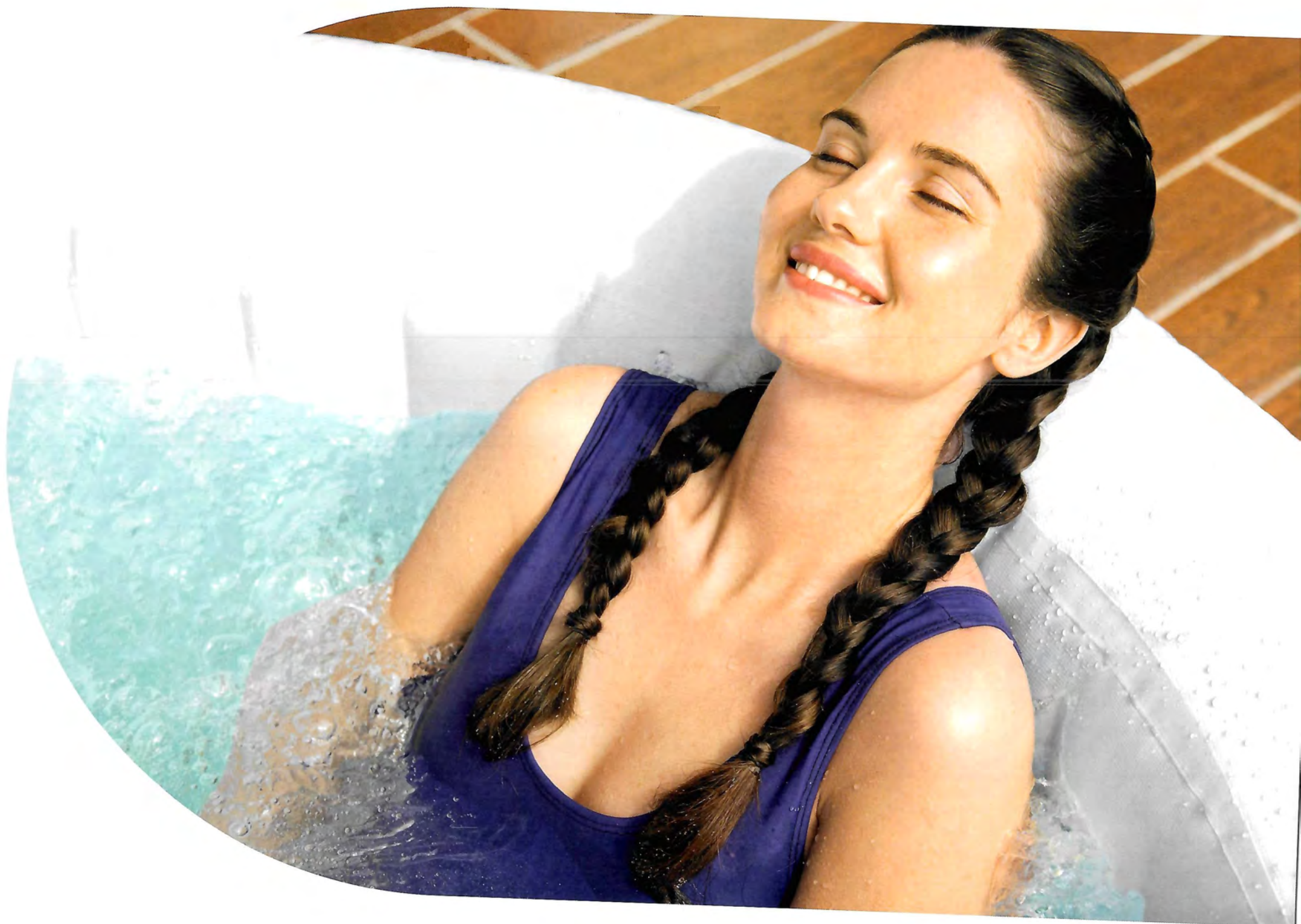

# MATERIAL TECHNOLOGY

## BEAM CONSTRUCTION DELIVERING STRENGTH AND COMFORT

The internal construction of each spa is designed to offer superior structural stability while still maintaining a comfortable surface. It always provides a luxurious spa experience, no matter how many times it's inflated or deflated.

## MAXHOLD™ MATERIAL DURABLE COMFORT

MaxHold™ internal beams maintain their shape over time, enabling the spa to hold its intended pressure and sturdiness. Made from a durable fabric material rather than PVC, they set the standard for internal stretch-resistance in the spa market.



## FORTIFIBER™ MATERIAL DROP STITCH DURABILITY

Inflated walls made from FortiFiber™ material provide unparalleled strength. Thousands of fine threads securely connect the sidewalls, which seal in air to create a rigid and sturdy spa. Not only great for durability, but this also makes the spa more spacious on the inside.

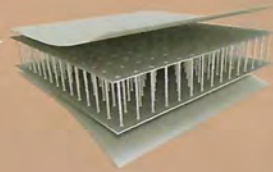



## SPA MATERIAL CONSTRUCTION

### WALL AND TOP RING

Our spas feature DuraPlus™ 3-ply material that makes up the external layer of the hot tub. The material is an exclusive formula of mesh encased in PVC to increase the strength, puncture-resistance and overall longevity of the spa.





# NEW SPA NAMING CONVENTIONS

For streamlined alignment within the spa category, we updated the naming conventions to be determined by 3 major factors.

## 1. FAMILY GROUPS

THE OFFICIAL NAME WILL BE A CITY DETERMINED BY THE SHAPE AND USER CAPACITY:

SHAPE	Round	Round	Round	Round	Square	Oval	Round	Square	Round
USER CAPACITY	2-3 Adults	2-4 Adults	3-5 Adults	4-6 Adults	4-6 Adults	5-7 Adults	5-7 Adults	5-7 adults	6-8 Adults
FAMILY NAME	St. Lucica	Miami	Bali	Paris	Hawaii	Mauritius	Santorini	Maldives	Grenada

## 2. SPECIAL FEATURE

A PRE-DEFINED DESCRIPTOR IS ADDED TO THE NAME BASED ON THE FOLLOWING HIERARCHY:

SPECIAL FEATURE	EnergySense™	Smart	Luxe	Signature
MEANING	Thermal liner	Wi-Fi integration	LED lights	Graphic print

\*If more than one special feature is present on the product, the item will take the name of the highest-ranking feature in the hierarchy.

## 3. MASSAGE SYSTEM

THE NAME OF THE MASSAGE SYSTEM IS ADDED TO THE END OF THE NAME:

MASSAGE SYSTEM	AirJet™	AirJet Plus™	HydroJet™	HydroJet Pro™
----------------	---------	--------------	-----------	---------------

## 4. MATERIAL SERIES

Spa packaging will receive an update to include upgraded callout treatment for premium materials along the right hand side of the front and back panels.

MATERIAL

FortiFiber™ Series

ThermaCore™ Series

MaxHold™ Series

## IMPLEMENTATION

All existing products will be updated to include the Special Feature and Material Series, but they will keep the existing city name.

All new products beginning in the 2024 season will follow the new convention system outlined here.

Some naming conventions may apply to Special Edition spas only.

### PACKAGING EXAMPLE:



2. SPECIAL FEATURE

1. FAMILY GROUP

4. MATERIAL SERIES

3. MASSAGE SYSTEM

Bestway®

# SMART HUB™ APP



## HEAT CONTROL

Create, save and edit multiple timers to apply the perfect temperature anytime throughout the week



## SET TIMER

Set the Power Saving Timer to only run the system during the selected times



## FILTRATION

Allows for multiple timers to be created for water filter activation



## MASSAGE SETTINGS

Run the massage system with the touch of a button



## MASSAGE REGULATION

A special feature on some spas allows the user to choose from two massage bubble intensity levels, giving them control over their relaxation experience



## APP CONNECTION

DELIVERING CONVENIENCE AND COMFORT  
With the Bestway Smart Hub™ app, control is right in the palm of your hand. This innovation makes the Lay-Z-Spa one of the most convenient in the market. Compatible with smart devices, the Spa Control section of the app lets you control the spa's temperature, activate the Power Saving Timer, change the water filter and control the massage system with just the touch of a button!



## QUICK SET-UP

- 1  
DOWNLOAD THE  
BESTWAY SMART  
HUB™ APP
- 2  
CLICK ON SPA
- 3  
FOLLOW  
THE SET-UP  
INSTRUCTIONS

# PLANOGRAM



PACKAGING NOT TO SCALE

# 2024 LAY-Z-SPA COLLECTION

## FEATURES KEY

-  SMART HUB™ APP
-  FREEZE SHIELD™
-  LED LIGHTS
-  FOOT MASSAGE
-  MASSAGE REGULATION
-  INTEGRATED SEATS
-  ENERGYSENSE™

### 2-3 ADULTS | ROUND

				
	ST. LUCIA 60037	MIAMI 60001	BAHAMAS SIGNATURE 60005	FIJI SIGNATURE 60085
MASSAGE TECH	AIRJET™	AIRJET™	AIRJET™	AIRJET™
MATERIAL	PVC & DURAPLUS™	PVC & DURAPLUS™	PVC & DURAPLUS™	PVC & DURAPLUS™
INFLATED SIZE	1.70 m x 66 cm (67" x 26")	1.80 m x 66 cm (71" x 26")	1.80 m x 66 cm (71" x 26")	1.80 m x 66 cm (71" x 26")
INNER SIZE	1.24 m (49")	1.32 m (52")	1.32 m (52")	1.32 m (52")
WATER CAPACITY	605 L (160 gal.)	669 L (177 gal.)	669 L (177 gal.)	669 L (177 gal.)
NUMBER OF AIRJETS	110	120	120	120
NUMBER OF HYDROJETS	—	—	—	—
FEATURES				

### 4-6 ADULTS | ROUND

			 NEW GEN	 NEW GEN
	HOLLYWOOD LUXE 60059	BUDAPEST ENERGYSENSE™ 60179	HONOLULU SMART 60019	MILAN SMART 60029
MASSAGE TECH	AIRJET™	AIRJET™	AIRJET™	AIRJET PLUS™
MATERIAL	PVC & DURAPLUS™	ENERGYSENSE™	DURAPLUS™ & MAXHOLD™	DURAPLUS™ & MAXHOLD™
INFLATED SIZE	1.96 m x 66 cm (77" x 26")	1.96 m x 66 cm (77" x 26")	1.96 m x 71 cm (77" x 28")	1.96 m x 71 cm (77" x 28")
INNER SIZE	1.48 m (58")	1.48 m (58")	1.46 m (57")	1.46 m (57")
WATER CAPACITY	908 L (240 gal.)	908 L (240 gal.)	916 L (242 gal.)	916 L (242 gal.)
NUMBER OF AIRJETS	140	140	140	140
NUMBER OF HYDROJETS	—	—	—	—
FEATURES	 	   	  	   

2-4 ADULTS | ROUND

4-6 ADULTS | SQUARE

					
<b>HAVANA SMART 60035</b>	<b>BORACAY SMART 60175</b>	<b>ZURICH ENERGYSENSE™ 60065</b>	<b>IBIZA 60015</b>	<b>HAWAII SMART 60261</b>	<b>HAWAII SMART 60021</b>
AIRJET™	AIRJET™	AIRJET™	AIRJET™	AIRJET™	AIRJET™
PVC & DURAPLUS™	PVC & DURAPLUS™	ENERGYSENSE™	PVC & DURAPLUS™	PVC & DURAPLUS™	DURAPLUS™ & MAXHOLD™
1.80 m x 66 cm (71" x 26")	1.80 m x 66 cm (71" x 26")	1.80 m x 66 cm (71" x 26")	1.80 m x 1.80 m x 66 cm (71" x 71" x 26")	1.80 m x 1.80 m x 66 cm (71" x 71" x 26")	1.80 m x 1.80 m x 71 cm (71" x 71" x 28")
1.32 m (52")	1.32 m (52")	1.32 m (52")	1.32 m x 1.32 m (52" x 52")	1.32 m x 1.32 m (52" x 52")	1.30 m x 1.30 m (51" x 51")
669 L (177 gal.)	669 L (177 gal.)	669 L (177 gal.)	778 L (205 gal.)	778 L (205 gal.)	840 L (222 gal.)
120	120	120	140	140	140
—	—	—	—	—	—
  	  	 		   	  

5-7 ADULTS | ROUND

5-7 ADULTS | SQUARE

6-8 ADULTS | ROUND

					
<b>ST. MORITZ SMART 60023</b>	<b>HELSINKI SMART 60025</b>	<b>SANTORINI SMART 60075</b>	<b>MALDIVES SMART 60033</b>	<b>SAN FRANCISCO SMART 60161</b>	<b>GRENADA SMART 60135</b>
AIRJET™	AIRJET PLUS™	HYDROJET PRO™	HYDROJET PRO™	HYDROJET PRO™	AIRJET™
DURAPLUS™ & MAXHOLD™	FORTIFIBER™	DURAPLUS™ & MAXHOLD™	DURAPLUS™ & MAXHOLD™	DURAPLUS™ & MAXHOLD™	DURAPLUS™ & MAXHOLD™
2.16 m x 71 cm (85" x 28")	1.80 m x 66 cm (71" x 26")	2.16 m x 80 cm (85" x 31.5")	2.01 m x 2.01 m x 80 cm (79" x 79" x 31.5")	2.30 m x 2.30 m x 71 cm (90.5" x 90.5" x 28")	2.36 m x 71 cm (93" x 28")
1.66 m (65")	1.70 m (67")	1.66 m (65")	1.51 m x 1.51 m (59" x 59")	1.80 m x 1.80 m (71" x 71")	1.86 m (73")
1,190 L (314 gal.)	1,123 L (297 gal.)	1,190 L (314 gal.)	1,050 L (277 gal.)	1,180 L (312 gal.)	1,350 L (357 gal.)
180	180	180	180	180	190
—	—	10	8	10	—
  	   	      	      	      	  



# AIRJET™ SYSTEM

FLOAT AWAY ON A CLOUD OF  
BUBBLES WITH AN AIRJET MASSAGE.

Soothe your body and relax your mind  
with the touch of a button.

Simply press the massage button on the  
control panel, and the AirJet™ system will  
surround you with calming bubbles.



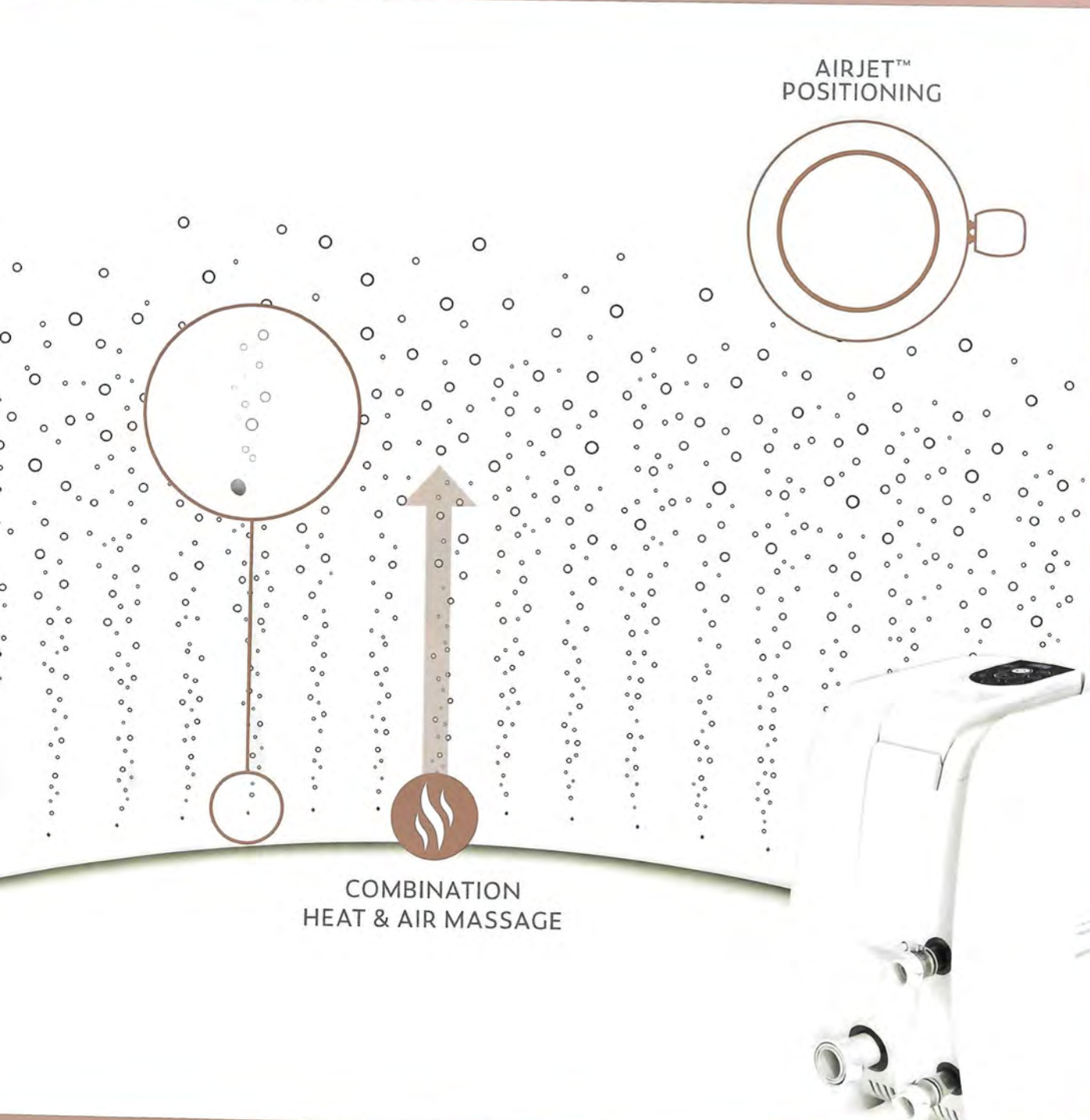

AIRJET™  
POSITIONING

COMBINATION  
HEAT & AIR MASSAGE



 MULTI-FUNCTION PUMP

The included spa pump is convenient and accessible, complete with a digital interface and cup holders. This pump inflates the spa, starts the heating and massage systems, and can activate the filtration system. The best part is the design now allows users to adjust their needs without standing up or exiting the spa.





LAY-Z-SPA  
ST. LUCIA

# ST. LUCIA

60037

- Soothing AirJet™ bubble massage system (110 jets)
- Ultra-strong DuraPlus™ walls are stress-tested to offer durability
- Freeze Shield™ automatic heating prevents water from freezing & damaging the spa
- Program the spa heater up to 40 days in advance for future use
- ChemConnect™ dispenser provides a stable level of chlorine throughout the spa
- Power-saving, timer-controlled heating system
- Digital control panel & spa pump with integrated filtration system includes cup holders and is accessible from inside the spa
- Reinforced cover with safety lock clips

## CONTENTS

- 1 spa
- 1 pool cover
- 1 spa pump
- 1 filter cartridge (VI)
- 1 ChemConnect™ dispenser
- 1 repair patch
- AirJet™ system



## DIMENSIONS

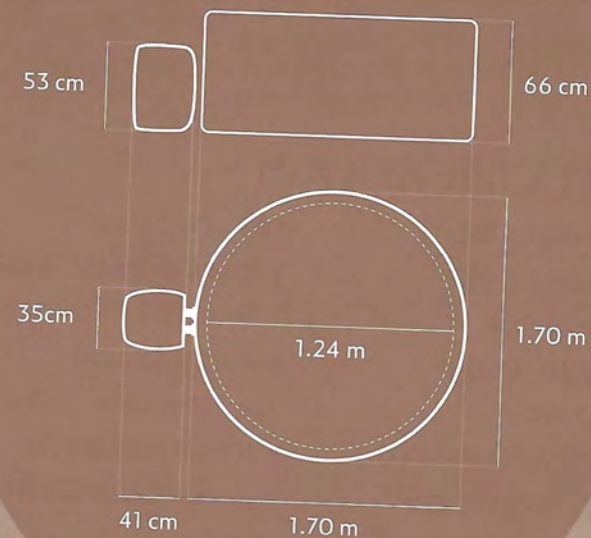

# ST. LUCIA

60037

## DURAPLUS™ MATERIAL WALL AND TOP RING

The outer surface of this spa is constructed with premium DuraPlus™ material, providing superior durability, stretch resistance and structural stability.

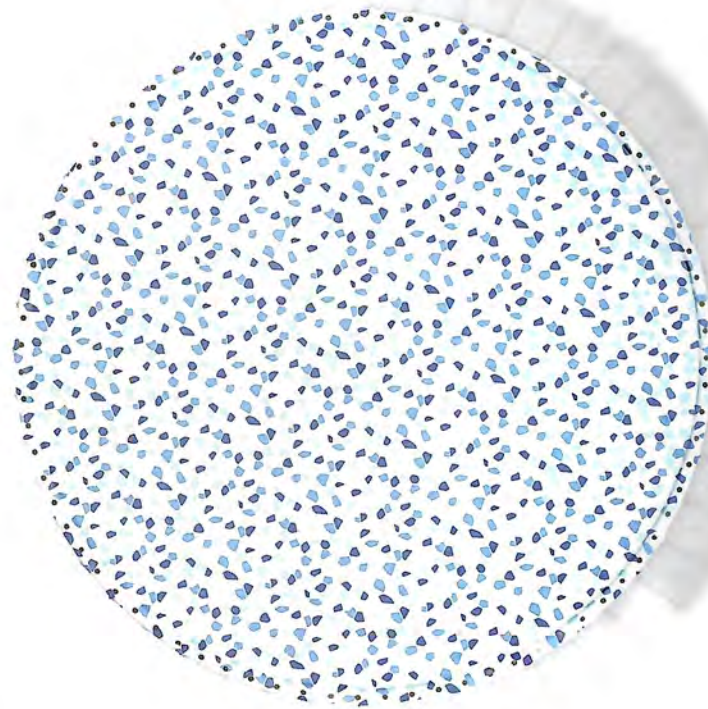

## SPECIFICATIONS

WATER CAPACITY	605 L (160 gal.)
INFLATED SIZE	1.70 m x 66 cm (67" x 26")
INNER SIZE	1.24 m (49")
FILLED WEIGHT	630 kg (1,389 lbs)
RATING	220-240V~ 50Hz, 2050W at 20°C (68°F)
ACTUAL WATER FLOW	1,325 L/h (350 gal./h)
HEATING SYSTEM	Approx. 1.5-2.0°C/h (3-4°F/h)
CERTIFICATION	CE/GS
PACK/GROSS WEIGHT	1 Ea., 32.41 kg (71.45 lbs)

## FEATURES



FREEZE  
SHIELD™



AIRJET™  
MASSAGE SYSTEM



MULTI-FUNCTION  
PUMP



CAPACITY  
2-3 PEOPLE



# DIGITAL CONTROL PANEL

- LED Display
- Lock/Unlock Button
- Power Saving Timer
- Celsius/Fahrenheit
- Heat Activation
- Temperature/ Hour Adjustment
- Power Button ON/OFF
- Water Filter Activation
- AirJet™ Massage





LAY-Z-SPA<sup>®</sup>  
MIAMI

# MIAMI

60001

- Soothing AirJet™ bubble massage system (120 jets)
- Ultra-strong DuraPlus™ walls are stress-tested to offer durability
- Freeze Shield™ automatic heating prevents water from freezing & damaging the spa
- Program the spa heater up to 40 days in advance for future use
- ChemConnect™ dispenser provides a stable level of chlorine throughout the spa
- Power-saving, timer-controlled heating system
- Digital control panel & spa pump with integrated filtration system includes cup holders and is accessible from inside the spa
- Reinforced cover with safety lock clips

## CONTENTS

- 1 spa
- 1 pool cover
- 1 spa pump
- 1 filter cartridge (VI)
- 1 ChemConnect™ dispenser
- 1 repair patch
- AirJet™ system



## DIMENSIONS

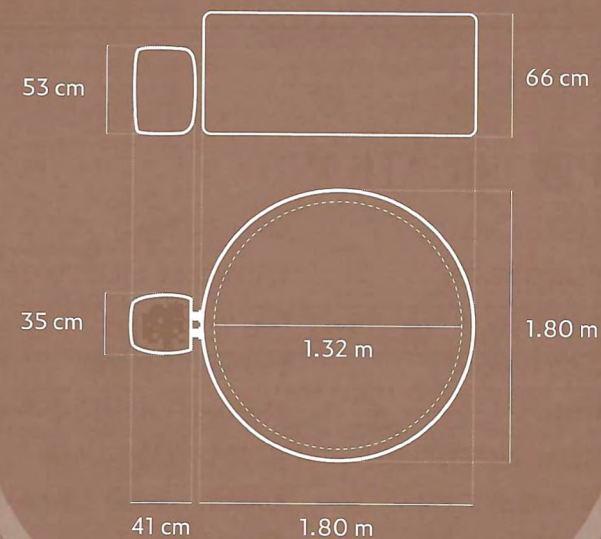

# MIAMI

60001

## DURAPLUS™ MATERIAL

### WALL AND TOP RING

The outer surface of this spa is constructed with premium DuraPlus™ material, providing superior durability, stretch resistance and structural stability.

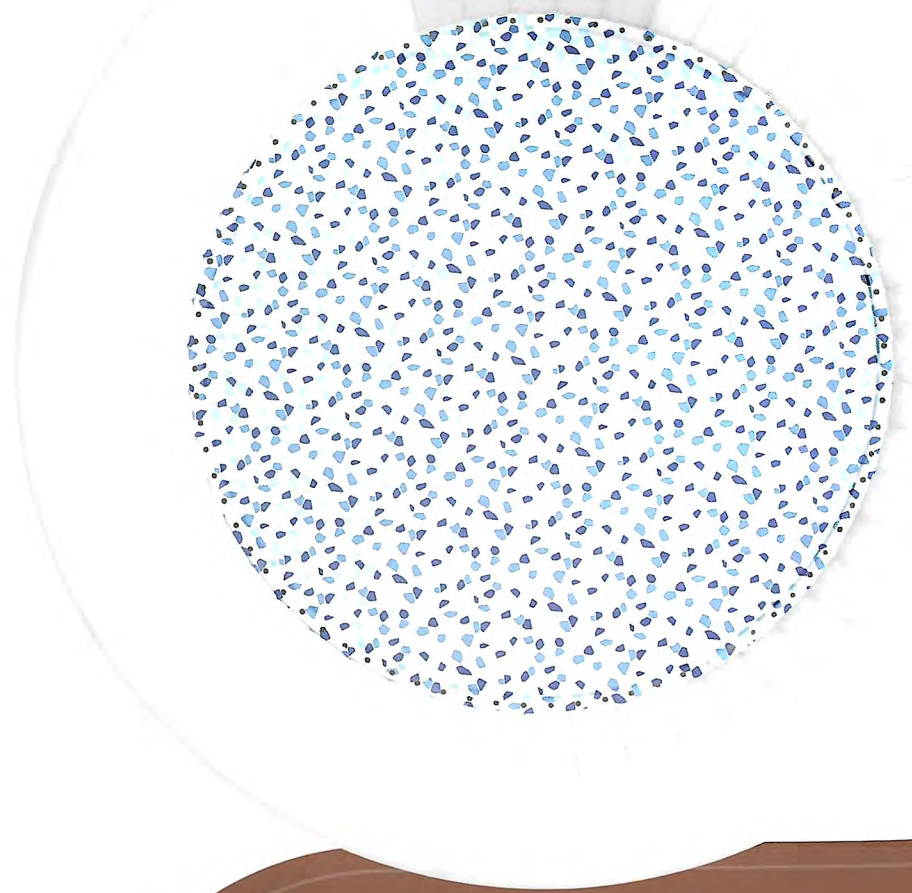

## SPECIFICATIONS

WATER CAPACITY	669 L (177 gal.)
INFLATED SIZE	1.80 m x 66 cm (71" x 26")
INNER SIZE	1.32 m (52")
FILLED WEIGHT	696 kg (1,534 lbs)
RATING	220-240V~ 50Hz, 2050W at 20°C (68°F)
ACTUAL WATER FLOW	1,325 L/h (350 gal./h)
HEATING SYSTEM	Approx. 1.5-2.0°C/h (3-4°F/h)
CERTIFICATION	CE/GS
PACK/GROSS WEIGHT	1 Ea., 33.93 kg (74.80 lbs)

## FEATURES



FREEZE SHIELD™



AIRJET™  
MESSAGE SYSTEM



MULTI-FUNCTION  
PUMP



CAPACITY  
2-4 PEOPLE



## DIGITAL CONTROL PANEL

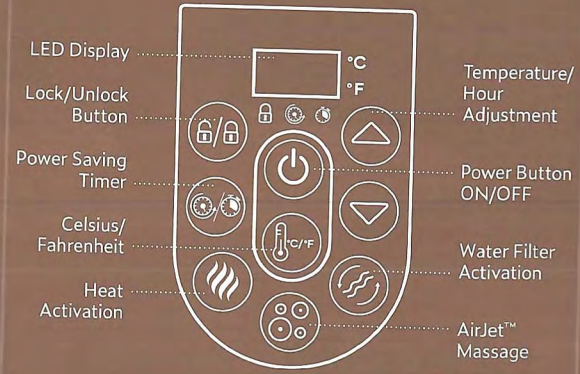





LAY-Z-SPA.  
BAHAMAS



## DIGITAL CONTROL PANEL

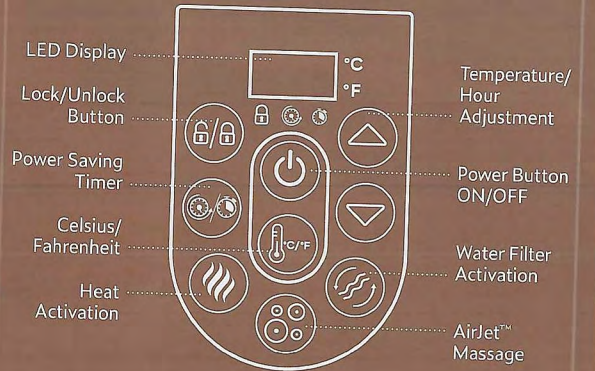



LAY-Z-SPA  
FLU

# FIJI

## SIGNATURE

60085

- Soothing AirJet™ bubble massage system (120 jets)
- Ultra-strong DuraPlus™ walls are stress-tested to offer durability
- Freeze Shield™ automatic heating prevents water from freezing & damaging the spa
- Program the spa heater up to 40 days in advance for future use
- ChemConnect™ dispenser provides a stable level of chlorine throughout the spa
- Power-saving, timer-controlled heating system
- Digital control panel & spa pump with integrated filtration system includes cup holders and is accessible from inside the spa
- Reinforced cover with safety lock clips

### CONTENTS

- 1 spa
- 1 pool cover
- 1 spa pump
- 1 filter cartridge (VI)
- 1 ChemConnect™ dispenser
- 1 repair patch
- AirJet™ system



### DIMENSIONS

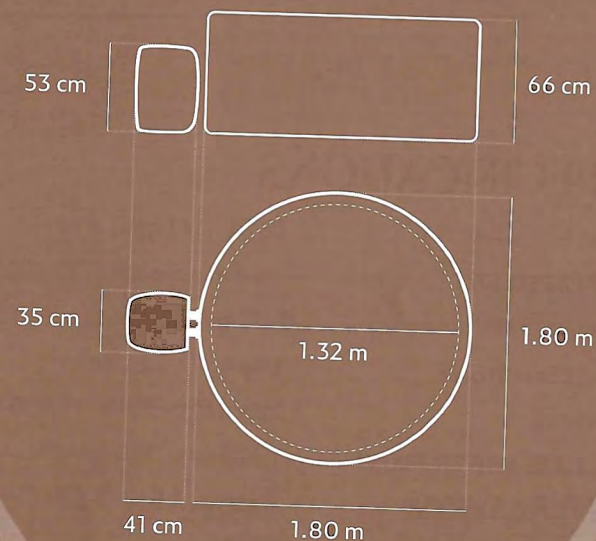

# FIJI

## SIGNATURE

60085

### DURAPLUS™ MATERIAL

#### WALL AND TOP RING

The outer surface of this spa is constructed with premium DuraPlus™ material, providing superior durability, stretch resistance and structural stability.

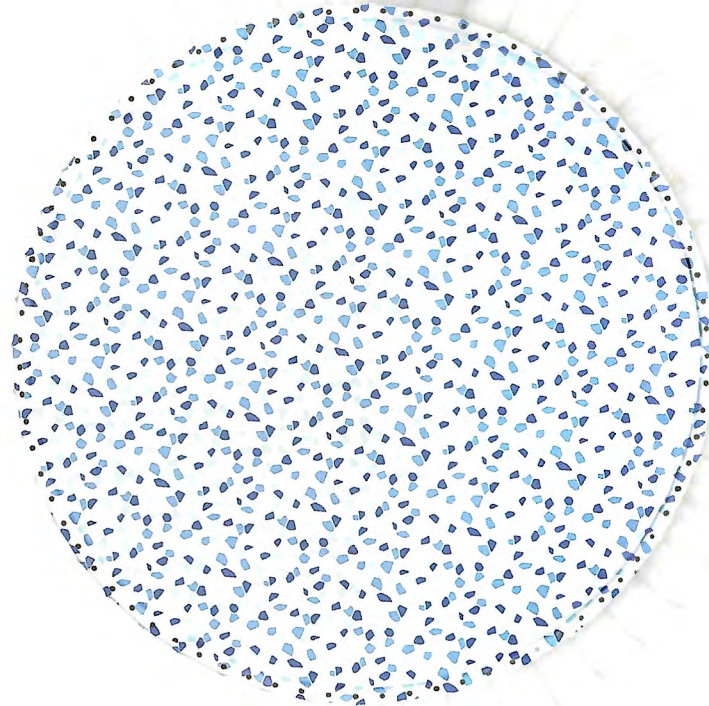
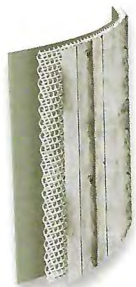

### SPECIFICATIONS

WATER CAPACITY	669 L (177 gal.)
INFLATED SIZE	1.80 m x 66 cm (71" x 26")
INNER SIZE	1.32 m (52")
FILLED WEIGHT	696 kg (1,534 lbs)
RATING	220-240V~ 50Hz, 2050W at 20°C (68°F)
ACTUAL WATER FLOW	1,325 L/h (350 gal./h)
HEATING SYSTEM	Approx. 1.5-2.0°C/h (3-4°F/h)
CERTIFICATION	CE/GS
PACK/GROSS WEIGHT	1 Ea., 33.93 kg (74.80 lbs)

### FEATURES



FREEZE SHIELD™



AIRJET™  
MASSAGE SYSTEM

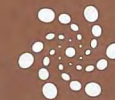

MULTI-FUNCTION  
PUMP



CAPACITY  
2-4 PEOPLE



## DIGITAL CONTROL PANEL

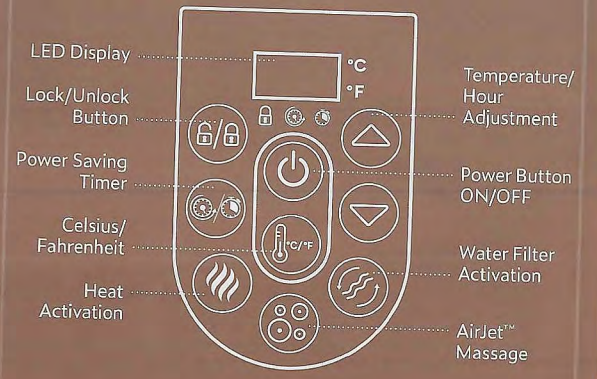



LAY-Z-SPA.  
HAVANA

# HAVANA SMART

60035

- Soothing AirJet™ bubble massage system (120 jets)
- Massage regulator provides 2 intensity level options
- Ultra-strong DuraPlus™ walls are stress-tested to offer durability
- Freeze Shield™ automatic heating prevents water from freezing & damaging the spa
- Program the spa heater up to 40 days in advance for future use
- Built-in Wi-Fi module, spa can be controlled through a phone app
- ChemConnect™ dispenser provides a stable level of chlorine throughout the spa
- Power-saving, timer-controlled heating system
- Digital control panel & spa pump with integrated filtration system includes cup holders and is accessible from inside the spa
- Reinforced cover with safety lock clips

## CONTENTS

- 1 spa
- 1 pool cover
- 1 spa pump
- 1 filter cartridge (VI)
- 1 ChemConnect™ dispenser
- 1 repair patch
- AirJet™ system



## DIMENSIONS

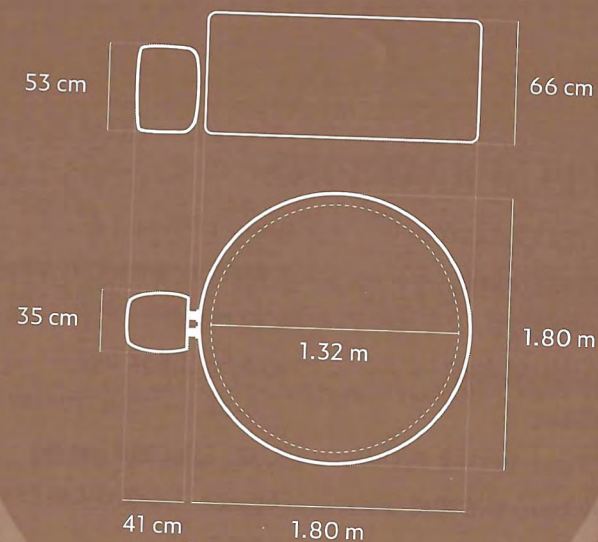



# HAVANA SMART

60035

## DURAPLUS™ MATERIAL

### WALL AND TOP RING

The outer surface of this spa is constructed with premium DuraPlus™ material, providing superior durability, stretch resistance and structural stability.

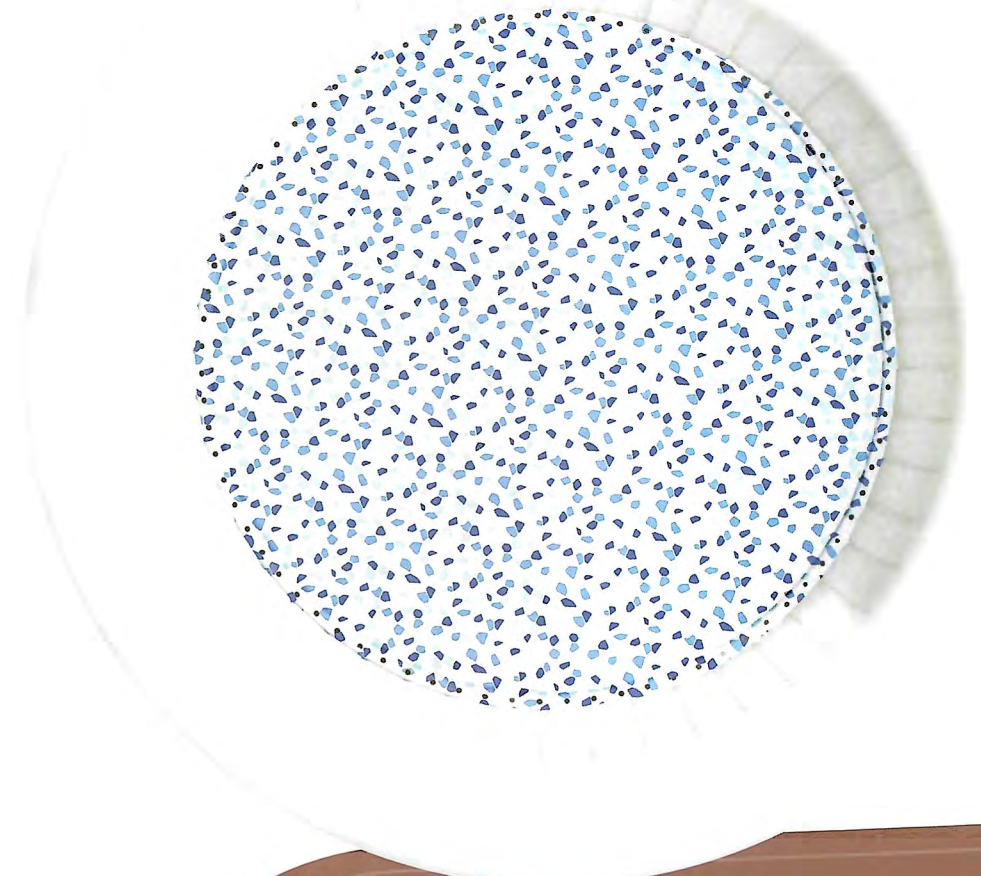

## SPECIFICATIONS

WATER CAPACITY	669 L (177 gal.)
INFLATED SIZE	1.80 m x 66 cm (71" x 26")
INNER SIZE	1.32 m (52")
FILLED WEIGHT	696 kg (1,534 lbs)
RATING	220-240V~ 50Hz, 2050W at 20°C (68°F)
ACTUAL WATER FLOW	1,325 L/h (350 gal./h)
HEATING SYSTEM	Approx. 1.5-2.0°C/h (3-4°F/h)
CERTIFICATION	CE/GS
PACK/GROSS WEIGHT	1 Ea., 33.93 kg (74.80 lbs)

## FEATURES



FREEZE  
SHIELD™



AIRJET™  
MASSAGE SYSTEM

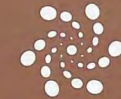

MULTI-FUNCTION  
PUMP



CAPACITY  
2-4 PEOPLE



MASSAGE  
REGULATION  
2 INTENSITY LEVELS



BESTWAY SMART  
HUB™ APP



## DIGITAL CONTROL PANEL

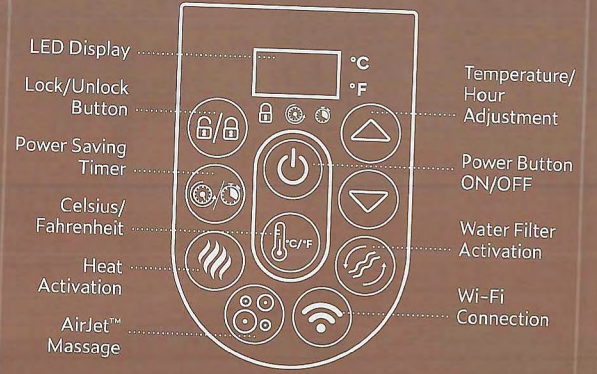



# BORACAY

## SMART

60175

- Soothing AirJet™ bubble massage system (120 jets)
- Massage regulator provides 2 intensity level options
- Ultra-strong DuraPlus™ walls are stress-tested to offer durability
- Freeze Shield™ automatic heating prevents water from freezing & damaging the spa
- Program the spa heater up to 40 days in advance for future use
- Built-in Wi-Fi module, spa can be controlled through a phone app
- ChemConnect™ dispenser provides a stable level of chlorine throughout the spa
- Power-saving, timer-controlled heating system
- Digital control panel & spa pump with integrated filtration system includes cup holders and is accessible from inside the spa
- Reinforced cover with safety lock clips

### CONTENTS

- 1 spa
- 1 pool cover
- 1 spa pump
- 1 filter cartridge (VI)
- 1 ChemConnect™ dispenser
- 1 repair patch
- AirJet™ system



### DIMENSIONS

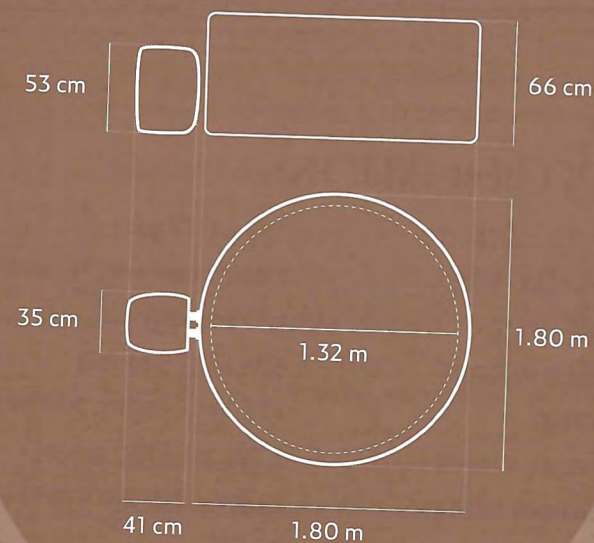

# BORACAY

## SMART

60175

### DURAPLUS™ MATERIAL

#### WALL AND TOP RING

The outer surface of this spa is constructed with premium DuraPlus™ material, providing superior durability, stretch resistance and structural stability.

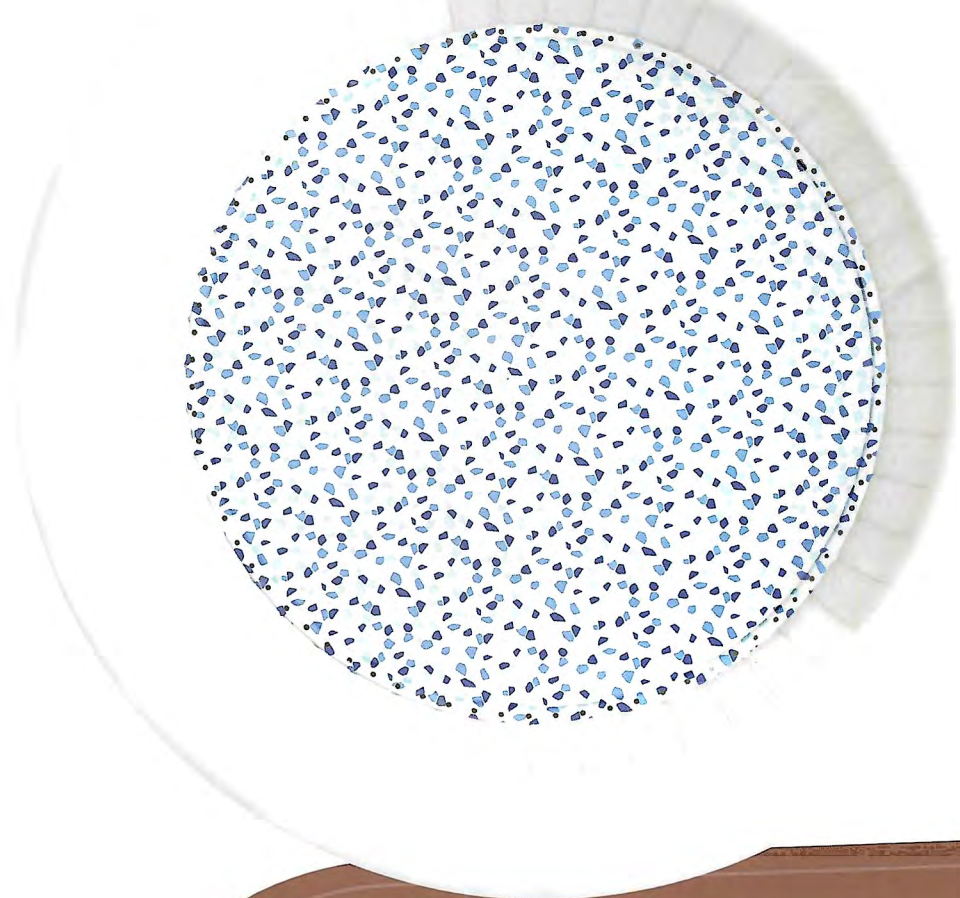

### SPECIFICATIONS

WATER CAPACITY	669 L (177 gal.)
INFLATED SIZE	1.80 m x 66 cm (71" x 26")
INNER SIZE	1.32 m (52")
FILLED WEIGHT	696 kg (1,534 lbs)
RATING	220-240V~ 50Hz, 2050W at 20°C (68°F)
ACTUAL WATER FLOW	1,325 L/h (350 gal./h)
HEATING SYSTEM	Approx. 1.5-2.0°C/h (3-4°F/h)
CERTIFICATION	CE/GS
PACK/GROSS WEIGHT	1 Ea., 33.93 kg (74.80 lbs)

### FEATURES



FREEZE SHIELD™



AIRJET™  
MESSAGE SYSTEM



MULTI-FUNCTION  
PUMP



CAPACITY  
2-4 PEOPLE



1x 2x  
MESSAGE  
REGULATION  
2 INTENSITY LEVELS



BESTWAY SMART  
HUB™ APP

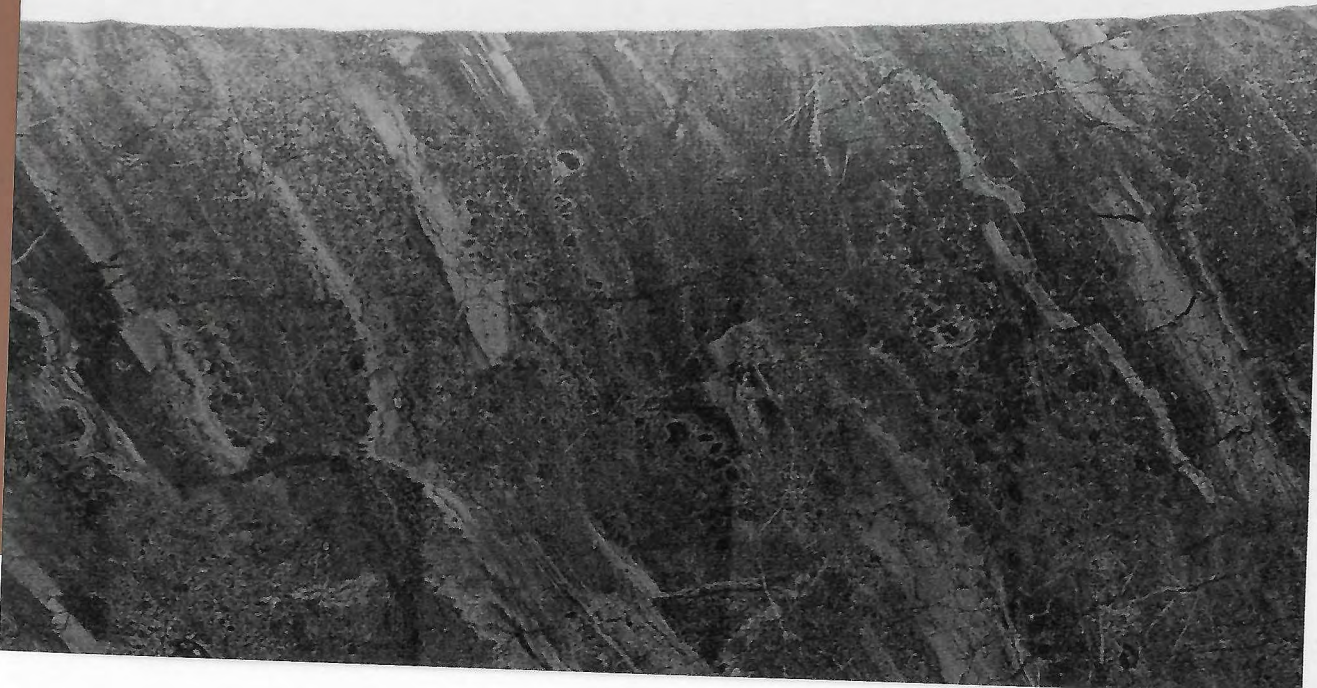

## DIGITAL CONTROL PANEL





# IBIZA

60015

- Soothing AirJet™ bubble massage system (140 jets)
- Ultra-strong DuraPlus™ walls are stress-tested to offer durability
- Freeze Shield™ automatic heating prevents water from freezing & damaging the spa
- Program the spa heater up to 40 days in advance for future use
- ChemConnect™ dispenser provides a stable level of chlorine throughout the spa
- Power-saving, timer-controlled heating system
- Digital control panel & spa pump with integrated filtration system includes cup holders and is accessible from inside the spa
- Reinforced cover with safety lock clips

## CONTENTS

- 1 spa
- 1 pool cover
- 1 spa pump
- 1 filter cartridge (VI)
- 1 ChemConnect™ dispenser
- 1 repair patch
- AirJet™ system



## DIMENSIONS

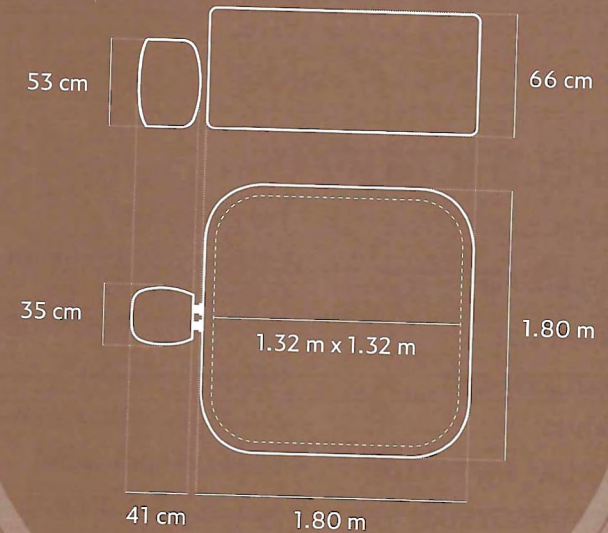



# IBIZA

60015

## DURAPLUS™ MATERIAL

### WALL AND TOP RING

The outer surface of this spa is constructed with premium DuraPlus™ material, providing superior durability, stretch resistance and structural stability.

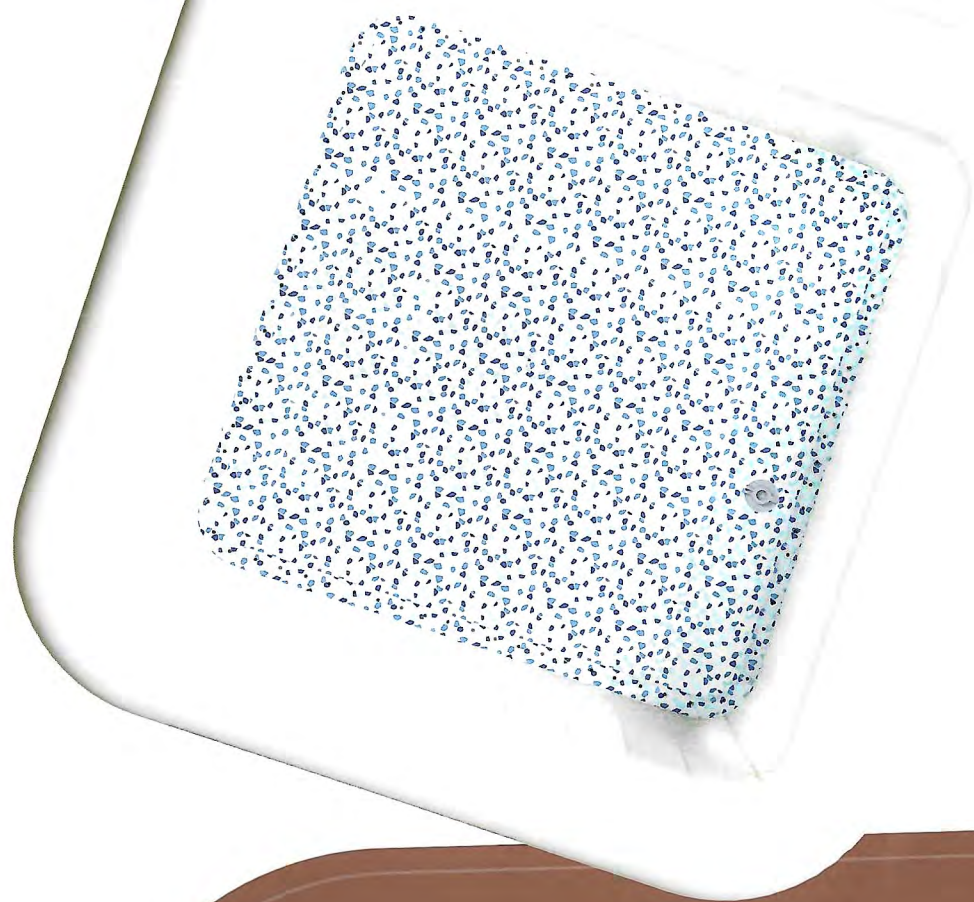

## SPECIFICATIONS

WATER CAPACITY	778 L (205 gal.)
INFLATED SIZE	1.80 m x 1.80 m x 66 cm (71" x 71" x 26")
INNER SIZE	1.32 m x 1.32m (52" x 52")
FILLED WEIGHT	808 kg (1,781 lbs)
RATING	220-240V~ 50Hz, 2050W at 20°C (68°F)
ACTUAL WATER FLOW	1,325 L/h (350 gal./h)
HEATING SYSTEM	Approx. 1.5-2.0°C/h (3-4°F/h)
CERTIFICATION	CE/GS
PACK/GROSS WEIGHT	1 Ea., 37.70 kg (83.11 lbs)

## FEATURES



FREEZE  
SHIELD™



AIRJET™  
MASSAGE SYSTEM



MULTI-FUNCTION  
PUMP



CAPACITY  
4-6 PEOPLE



## DIGITAL CONTROL PANEL

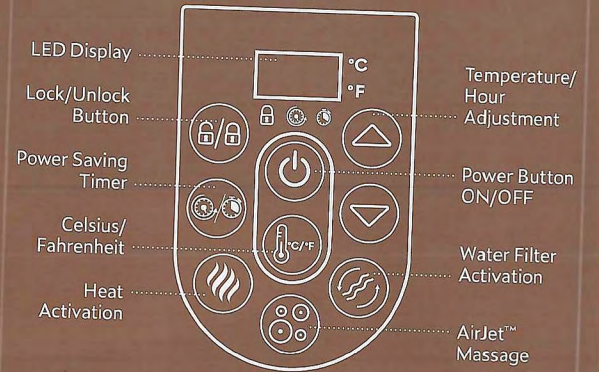



SCAN HERE  
TO SEE HOW  
IT WORKS



# HOLLYWOOD

## LUXE

60059

- Soothing AirJet™ bubble massage system (140 jets)
- Ultra-strong DuraPlus™ walls are stress-tested to offer durability
- Freeze Shield™ automatic heating prevents water from freezing & damaging the spa
- Program the spa heater up to 40 days in advance for future use
- ChemConnect™ dispenser provides a stable level of chlorine throughout the spa
- Remote-controlled plug-in multicolored LED light shines through the semi-transparent liner to illuminate the water



- Power-saving, timer-controlled heating system
- Digital control panel & spa pump with integrated filtration system includes cup holders and is accessible from inside the spa
- Reinforced cover with safety lock clips

### CONTENTS

- 1 spa
- 1 pool cover
- 1 spa pump
- 1 filter cartridge (VI)
- 1 ChemConnect™ dispenser
- 1 LED light strip
- 4 pillows
- 1 repair patch
- AirJet™ system



### DIMENSIONS

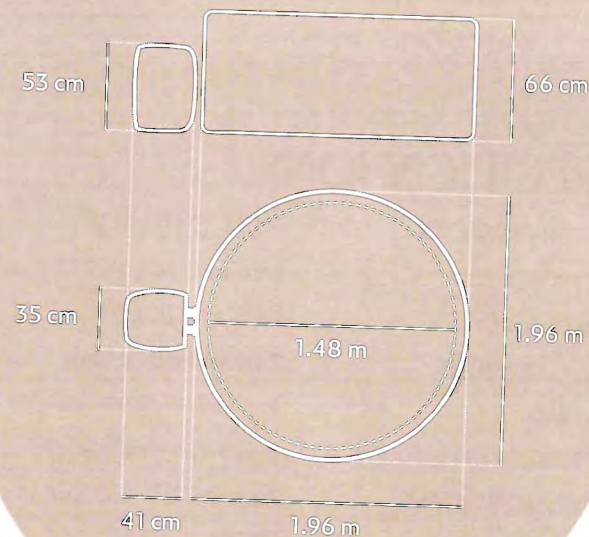

# HOLLYWOOD LUXE

60059

## DURAPLUS™ MATERIAL

### WALL AND TOP RING

The outer surface of this spa is constructed with premium DuraPlus™ material, providing superior durability, stretch resistance and structural stability.

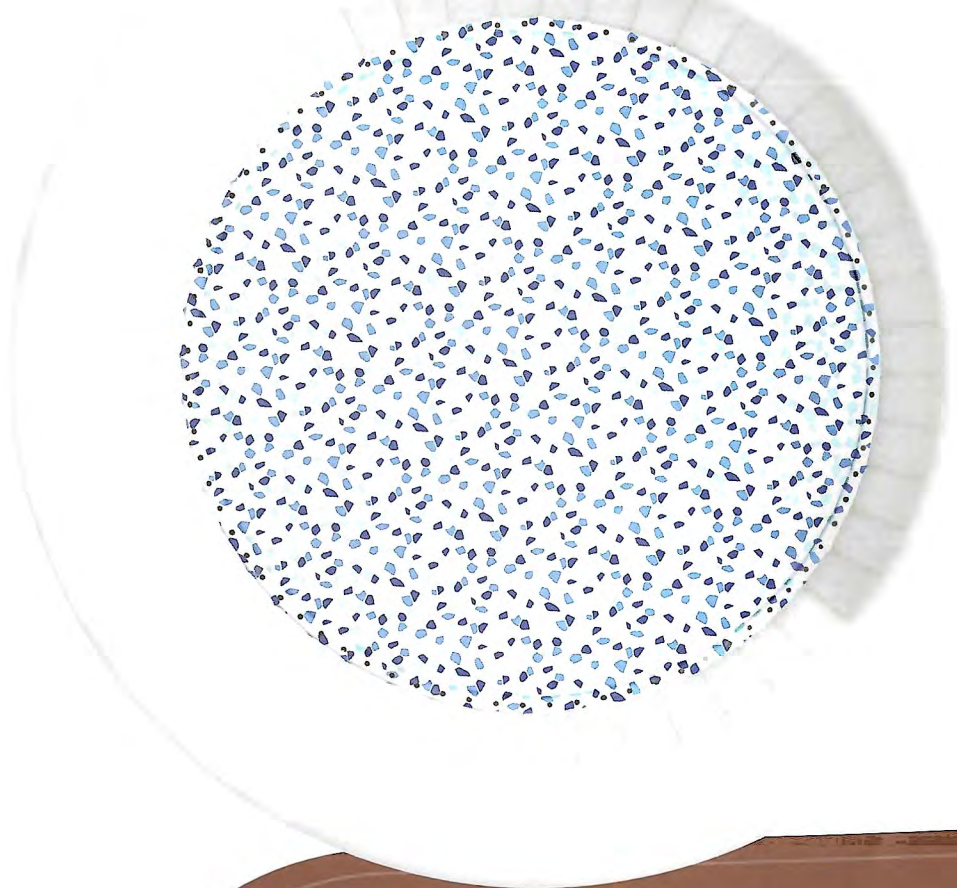

## SPECIFICATIONS

WATER CAPACITY	908 L (240 gal.)
INFLATED SIZE	1.96 m x 66 cm (77" x 26")
INNER SIZE	1.48 m (58")
FILLED WEIGHT	940 kg (2,072 lbs)
RATING	220-240V~ 50Hz, 2050W at 20°C (68°F)
ACTUAL WATER FLOW	1,325 L/h (350 gal./h)
HEATING SYSTEM	Approx. 1.5-2.0°C/h (3-4°F/h)
CERTIFICATION	CE/GS
PACK/GROSS WEIGHT	1 Ea., 39.27 kg (86.57 lbs)

## FEATURES



FREEZE  
SHIELD™



AIRJET™  
MASSAGE SYSTEM



MULTI-FUNCTION  
PUMP



CAPACITY  
4-6 PEOPLE



PADDED  
PILLOWS



7-COLOR  
LED LIGHTS



## DIGITAL CONTROL PANEL

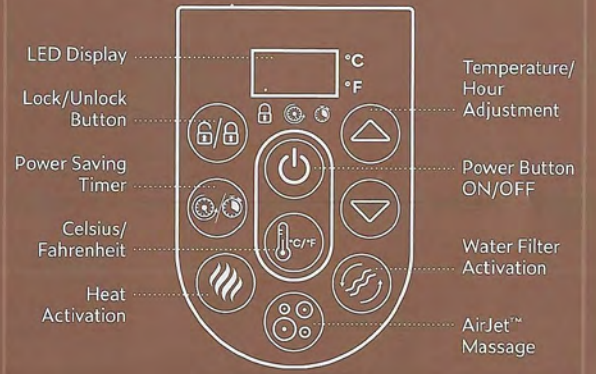



NEW

# HAWAII SMART

60261

- Soothing AirJet™ bubble massage system (140 jets)
- Massage regulator provides 2 intensity level options
- Ultra-strong DuraPlus™ walls are stress-tested to offer durability
- Freeze Shield™ automatic heating prevents water from freezing & damaging the spa
- Program the spa heater up to 40 days in advance for future use
- Built-in Wi-Fi module, spa can be controlled through a phone app
- ChemConnect™ dispenser provides a stable level of chlorine throughout the spa
- Remote-controlled plug-in multicolored LED light shines through the semi-transparent liner to illuminate the water
- Power-saving, timer-controlled heating system
- Digital control panel & spa pump with integrated filtration system includes cup holders and is accessible from inside the spa
- Reinforced cover with safety lock clips

## CONTENTS

- 1 spa
- 1 pool cover
- 1 spa pump
- 1 filter cartridge (VI)
- 1 ChemConnect™ dispenser
- 1 LED light strip
- 4 pillows
- 1 repair patch
- AirJet™ system



## DIMENSIONS

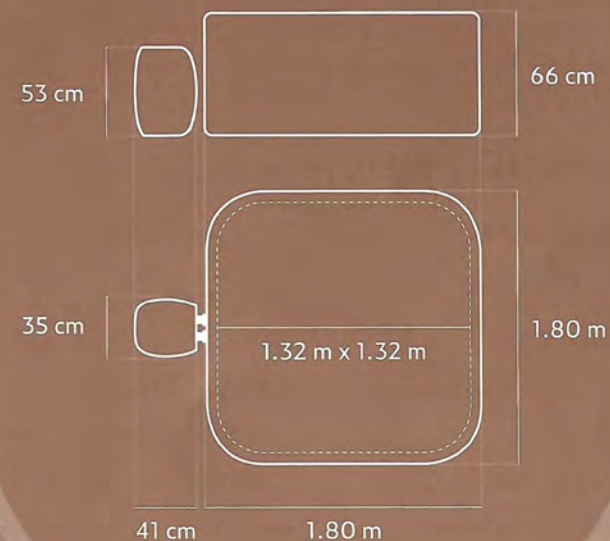



NEW

# HAWAII SMART

60261

## DURAPLUS™ MATERIAL

### WALL AND TOP RING

The outer surface of this spa is constructed with premium DuraPlus™ material, providing superior durability, stretch resistance and structural stability.



## SPECIFICATIONS

WATER CAPACITY	778 L (205 gal.)
INFLATED SIZE	1.80 m x 1.80 m x 66 cm (71" x 71" x 26")
INNER SIZE	1.32 m x 1.32m (52" x 52")
FILLED WEIGHT	810 kg (1,786 lbs)
RATING	220-240V~ 50Hz, 2050W at 20°C (68°F)
ACTUAL WATER FLOW	1,325 L/h (350 gal./h)
HEATING SYSTEM	Approx. 1.5-2.0°C/h (3-4°F/h)
CERTIFICATION	CE/GS
PACK/GROSS WEIGHT	1 Ea., 39.65 kg (87.41 lbs)

## FEATURES



FREEZE SHIELD™



AIRJET™  
MASSAGE SYSTEM



MULTI-FUNCTION  
PUMP



CAPACITY  
4-6 PEOPLE



PADDED  
PILLOWS



7-COLOR  
LED LIGHTS



MASSAGE  
REGULATION  
2 INTENSITY LEVELS



BESTWAY SMART  
HUB™ APP



## DIGITAL CONTROL PANEL





LAY-Z-SPA  
ZURICH

# ZURICH

## ENERGYSENSE™

60065

- Soothing AirJet™ bubble massage system (120 jets)
- EnergySense™ insulated cover makes this spa as much as 40% more energy efficient
- Ultra-strong DuraPlus™ walls are stress-tested to offer durability
- Freeze Shield™ automatic heating prevents water from freezing & damaging the spa
- Program the spa heater up to 40 days in advance for future use
- ChemConnect™ dispenser provides a stable level of chlorine throughout the spa
- Power-saving, timer-controlled heating system
- Reinforced cover with safety lock clips

### CONTENTS

- 1 pool liner
- 1 pool cover
- 1 spa pump
- 1 filter cartridge (VI)
- 1 ChemConnect™ dispenser
- 1 repair patch
- AirJet™ system



### DIMENSIONS

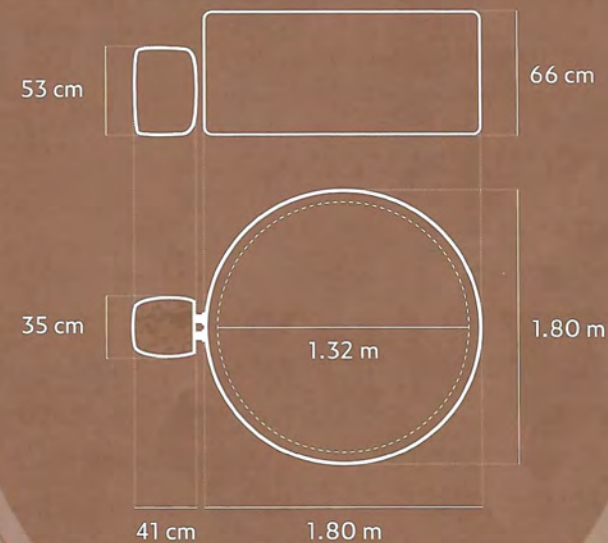

# ZURICH

## ENERGYSENSE™

60065

### DURAPLUS™ MATERIAL

#### WALL AND TOP RING

The outer surface of this spa is constructed with premium DuraPlus™ material, providing superior durability, stretch resistance and structural stability.

### ENERGYSENSE™ INSULATED COVER

Insulated cover speeds up heating time and prevents heat loss, making the Zurich as much as 40% more energy efficient than similar inflatable spas.

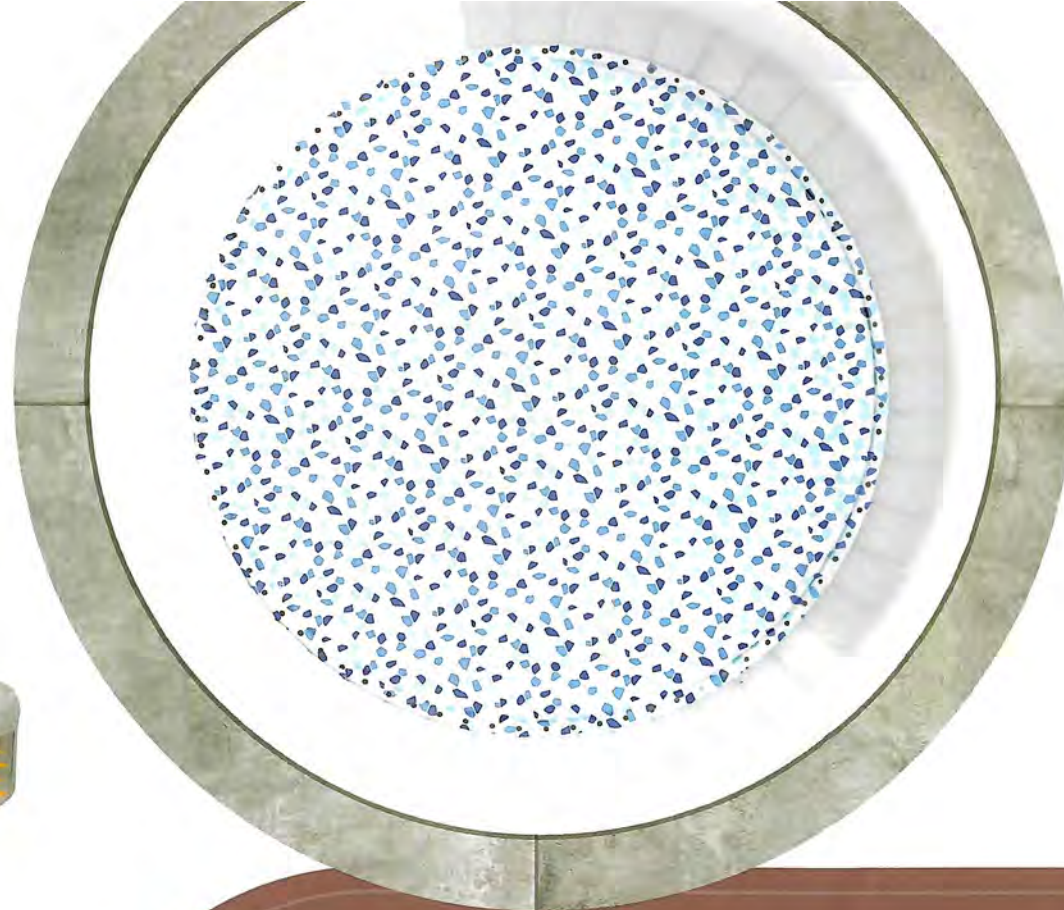

## SPECIFICATIONS

WATER CAPACITY	669 L (177 gal.)
INFLATED SIZE	1.80 m x 66 cm (71" x 26")
INNER SIZE	1.32 m (52" )
FILLED WEIGHT	703 kg (1,550 lbs)
RATING	220-240V~ 50Hz, 2050W at 20°C (68°F)
ACTUAL WATER FLOW	1,325 L/h (350 gal./h)
HEATING SYSTEM	Approx. 1.8-2.4°C/h (3-4°F/h)
CERTIFICATION	CE/GS
PACK/GROSS WEIGHT	1 Ea., 43.85 kg (96.67 lbs)

## FEATURES



FREEZE SHIELD™



AIRJET™ MASSAGE SYSTEM



MULTI-FUNCTION PUMP



CAPACITY 2-4 PEOPLE



ENERGYSENSE™ COVER



## DIGITAL CONTROL PANEL





# BUDAPEST

## ENERGYSENSE™

60179

- Soothing AirJet™ bubble massage system (140 jets)
- Massage regulator provides 2 intensity level options
- EnergySense™ insulated cover makes this spa as much as 40% more energy efficient
- Ultra-strong DuraPlus™ walls are stress-tested to offer durability
- Freeze Shield™ automatic heating prevents water from freezing & damaging the spa
- Program the spa heater up to 40 days in advance for future use
- Built-in Wi-Fi module, spa can be controlled through a phone app
- ChemConnect™ dispenser provides a stable level of chlorine throughout the spa
- Power-saving, timer-controlled heating system
- Reinforced cover with safety lock clips

### CONTENTS

- 1 pool liner
- 1 pool cover
- 1 spa pump
- 1 filter cartridge (VI)
- 1 ChemConnect™ dispenser
- 1 repair patch
- AirJet™ system



### DIMENSIONS

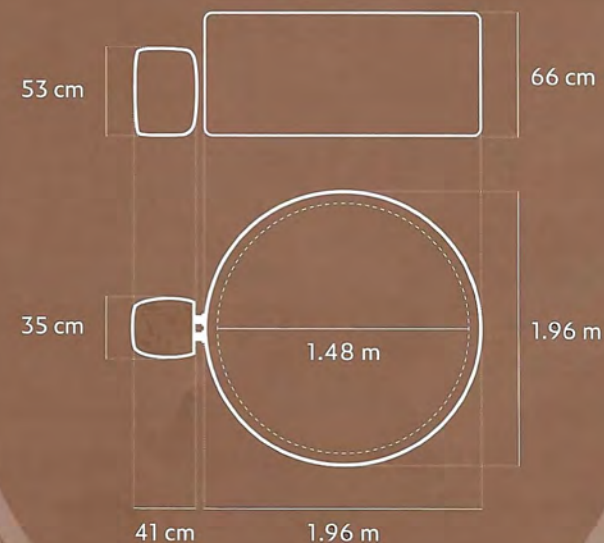



# BUDAPEST ENERGYSENSE™

60179

## DURAPLUS™ MATERIAL

### WALL AND TOP RING

The outer surface of this spa is constructed with premium DuraPlus™ material, providing superior durability, stretch resistance and structural stability.

## ENERGYSENSE™ INSULATED COVER

Insulated cover speeds up heating time and prevents heat loss, making the Budapest as much as 40% more energy efficient than similar inflatable spas.



## SPECIFICATIONS

WATER CAPACITY	908 L (240 gal.)
INFLATED SIZE	1.96 m x 66 cm (77" x 26")
INNER SIZE	1.48 m (58")
FILLED WEIGHT	945 kg (2,083 lbs)
RATING	220-240V~ 50Hz, 2050W at 20°C (68°F)
ACTUAL WATER FLOW	1,325 L/h (350 gal./h)
HEATING SYSTEM	Approx. 1.8-2.4°C/h (3-4°F/h)
CERTIFICATION	CE/GS
PACK/GROSS WEIGHT	1 Ea., 46.42 kg (102.34 lbs)

## FEATURES



FREEZE SHIELD™



AIRJET™  
MESSAGE SYSTEM



MULTI-FUNCTION  
PUMP



CAPACITY  
4-6 PEOPLE



1x MASSAGE  
REGULATION  
2x INTENSITY LEVELS



BESTWAY SMART  
HUB™ APP



ENERGYSENSE™  
COVER



## DIGITAL CONTROL PANEL





NEW  
GENERATION

# HONOLULU SMART

60019

- Soothing AirJet™ bubble massage system (140 jets)
- Massage regulator provides 2 intensity level options
- Ultra-strong DuraPlus™ walls are stress-tested to offer durability
- MaxHold™ fabric internal beams provide superior air pressure retention, stability and lightweight portability
- Freeze Shield™ automatic heating prevents water from freezing & damaging the spa
- Program the spa heater up to 40 days in advance for future use
- Built-in Wi-Fi module, spa can be controlled through a phone app
- ChemConnect™ dispenser provides a stable level of chlorine throughout the spa
- Power-saving, timer-controlled heating system
- Digital control panel & spa pump with integrated filtration system includes cup holders and is accessible from inside the spa
- Rattan print on outside with mosaic print on the inside
- Reinforced cover with safety lock clips

## CONTENTS

- 1 spa
- 1 pool cover
- 1 spa pump
- 1 filter cartridge (V1)
- 1 ChemConnect™ dispenser
- 1 repair patch
- AirJet® system



## DIMENSIONS

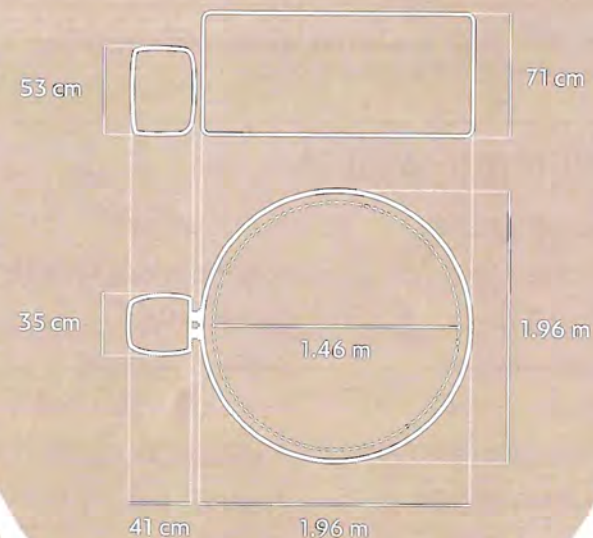

NEW  
GENERATION

# HONOLULU SMART

60019

## DURAPLUS™ MATERIAL

### WALL AND TOP RING

The outer surface of this spa is constructed with premium DuraPlus™ material, providing superior durability, stretch resistance and structural stability.

## MAXHOLD™ MATERIAL

### INTERNAL BEAMS

MaxHold™ internal beams maintain their shape over time, enabling the spa to hold its intended pressure and sturdiness. Made from a durable fabric material rather than PVC, they set the standard for internal stretch-resistance in the spa market.

## SPECIFICATIONS

WATER CAPACITY	916 L (242 gal.)
INFLATED SIZE	1.96 m x 71 cm (77" x 28")
INNER SIZE	1.46 m (57")
FILLED WEIGHT	947 kg (2,088 lbs)
RATING	220-240V~ 50Hz, 2050W at 20°C (68°F)
ACTUAL WATER FLOW	1,325 L/h (350 gal./h)
HEATING SYSTEM	Approx. 1.5-2.0°C/h (3-4°F/h)
CERTIFICATION	CE/GS
PACK/GROSS WEIGHT	1 Ea., 38.59 kg (85.08 lbs)

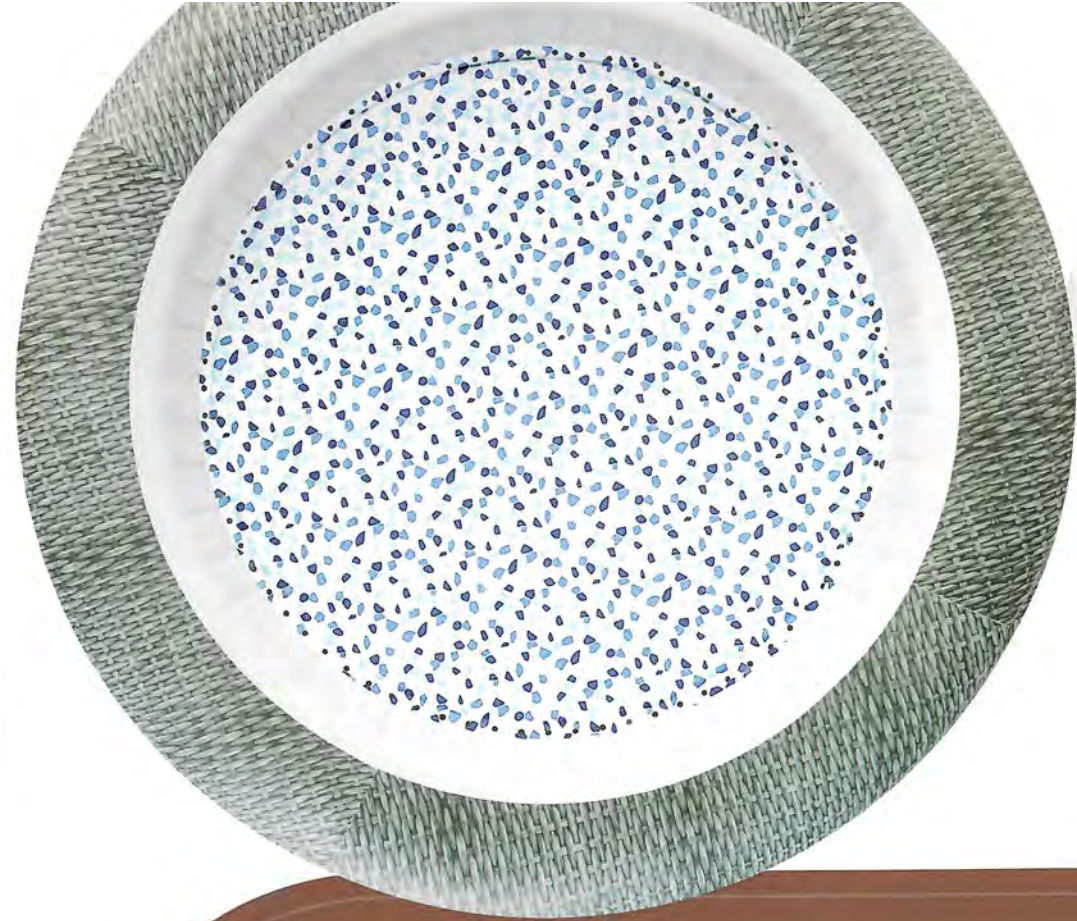

## FEATURES



FREEZE  
SHIELD™



AIRJET™  
MASSAGE SYSTEM



MULTI-FUNCTION  
PUMP



CAPACITY  
4-6 PEOPLE



1x MASSAGE  
REGULATION  
2x INTENSITY LEVELS



BESTWAY SMART  
HUB™ APP



## DIGITAL CONTROL PANEL





NEW  
GENERATION

# HAWAII SMART

60021

- Soothing AirJet™ bubble massage system (140 jets)
- Massage regulator provides 2 intensity level options
- Ultra-strong DuraPlus™ walls are stress-tested to offer durability
- MaxHold™ fabric & internal beams provide superior air pressure retention, stability and lightweight portability
- Freeze Shield™ automatic heating prevents water from freezing & damaging the spa
- Program the spa heater up to 40 days in advance for future use
- Built-in Wi-Fi module, spa can be controlled through a phone app
- ChemConnect™ dispenser provides a stable level of chlorine throughout the spa
- Power-saving, timer-controlled heating system
- Digital control panel & spa pump with integrated filtration system includes cup holders and is accessible from inside the spa
- Reinforced cover with safety lock clips

## CONTENTS

- 1 spa
- 1 pool cover
- 1 spa pump
- 1 filter cartridge (VI)
- 1 ChemConnect™ dispenser
- 1 repair patch
- AirJet™ system



## DIMENSIONS

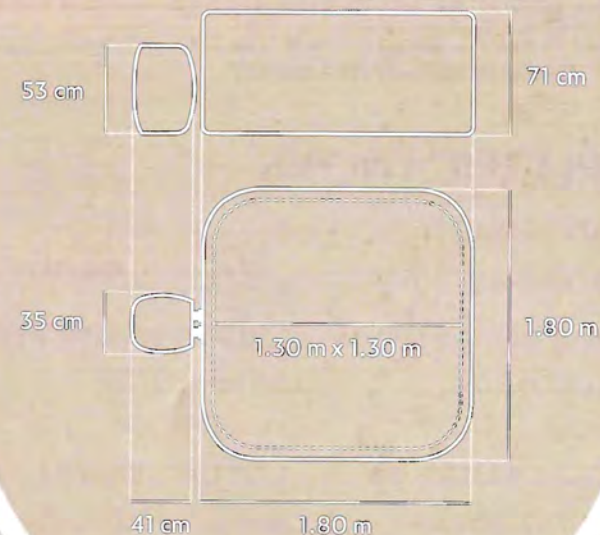



NEW  
GENERATION

# HAWAII SMART

60021

## DURAPLUS™ MATERIAL

### WALL AND TOP RING

The outer surface of this spa is constructed with premium DuraPlus™ material, providing superior durability, stretch resistance and structural stability.

## MAXHOLD™ MATERIAL

### INTERNAL BEAMS

MaxHold™ internal beams maintain their shape over time, enabling the spa to hold its intended pressure and sturdiness. Made from a durable fabric material rather than PVC, they set the standard for internal stretch-resistance in the spa market.

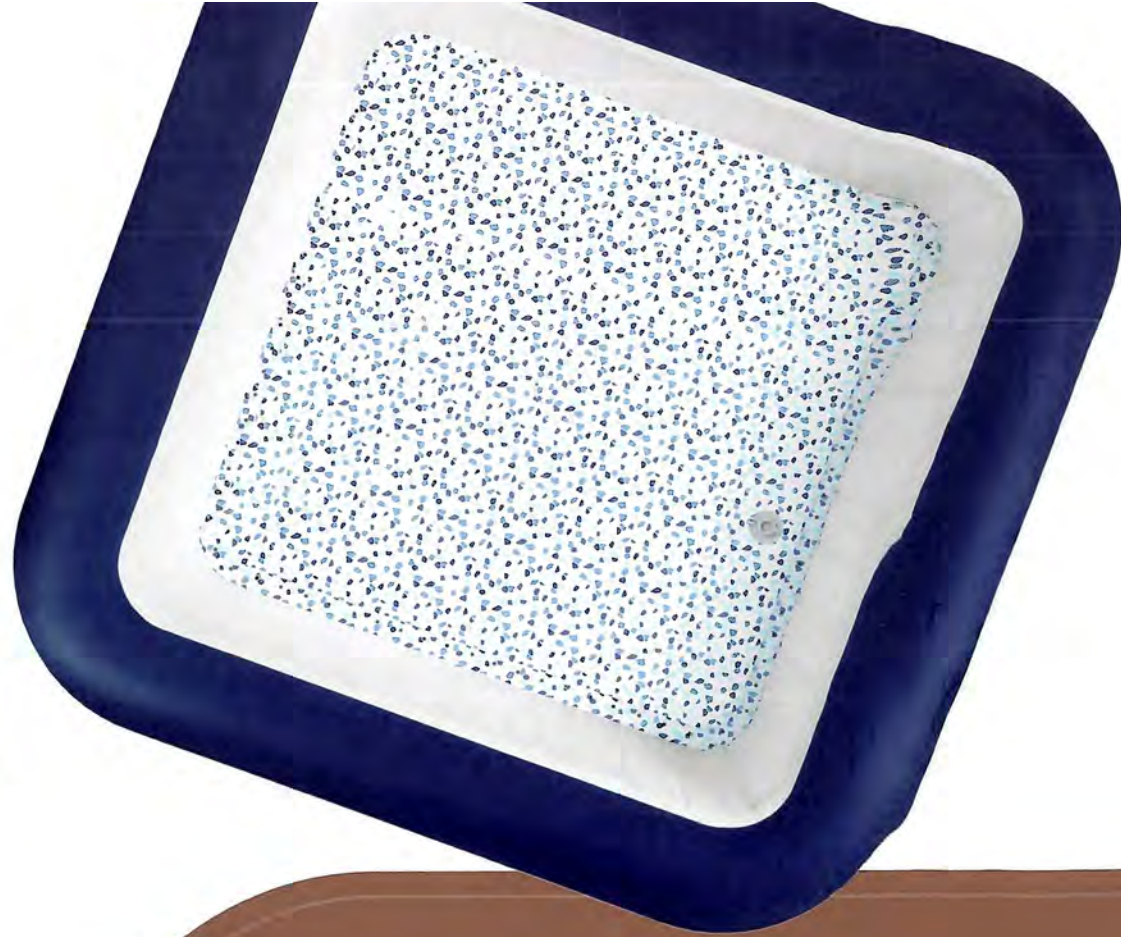

## SPECIFICATIONS

WATER CAPACITY	840 L (222 gal.)
INFLATED SIZE	1.80 m x 1.80 m x 71 cm (71" x 71" x 28")
INNER SIZE	1.30 m x 1.30 m (51" x 51")
FILLED WEIGHT	871 kg (1,921 lbs)
RATING	220-240V~ 50Hz, 2050W at 20°C (68°F)
ACTUAL WATER FLOW	1,325 L/h (350 gal./h)
HEATING SYSTEM	Approx. 1.5-2.0°C/h (3-4°F/h)
CERTIFICATION	CE/GS
PACK/GROSS WEIGHT	1 Ea., 38.30 kg (84.44 lbs)

## FEATURES



FREEZE  
SHIELD™



AIRJET™  
MASSAGE SYSTEM



MULTI-FUNCTION  
PUMP



CAPACITY  
4-6 PEOPLE



1x MASSAGE  
REGULATION  
2 INTENSITY LEVELS



BESTWAY SMART  
HUB™ APP

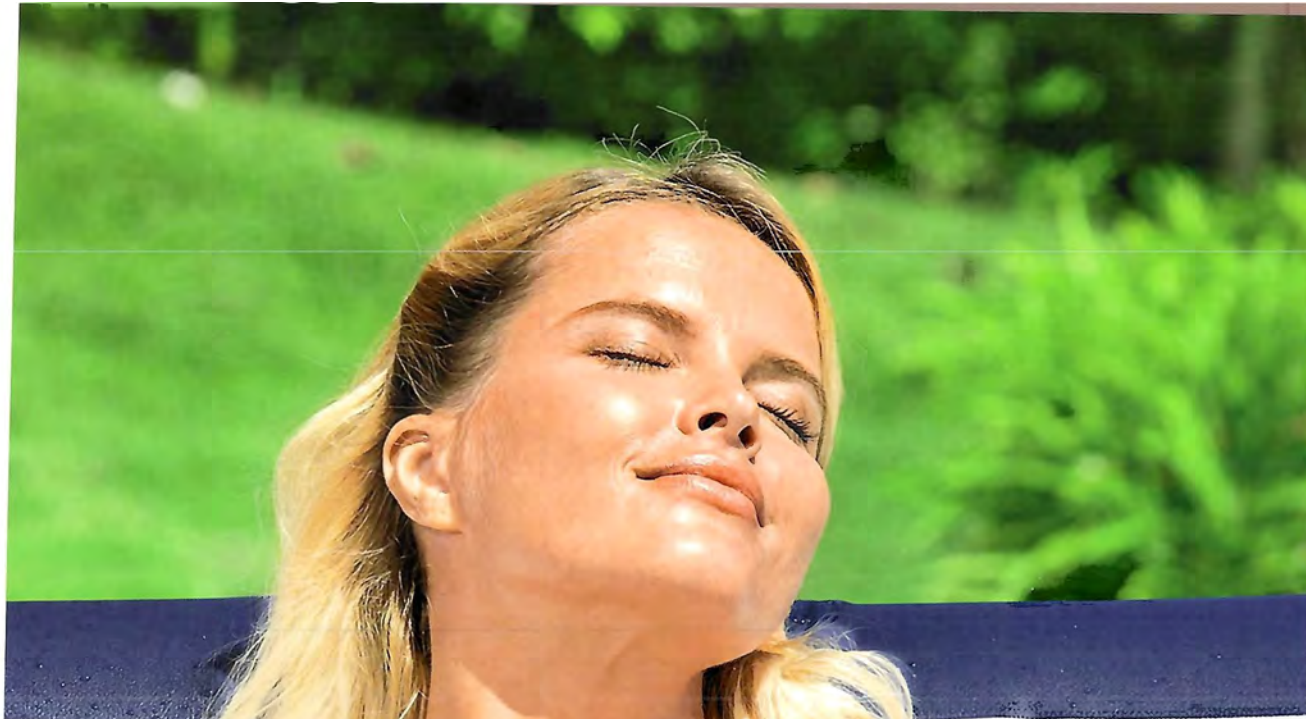

## DIGITAL CONTROL PANEL



NEW  
GENERATION

# ST. MORITZ SMART

60023

## DURAPLUS™ MATERIAL

### WALL AND TOP RING

The outer surface of this spa is constructed with premium DuraPlus™ material, providing superior durability, stretch resistance and structural stability.



## MAXHOLD™ MATERIAL

### INTERNAL BEAMS

MaxHold™ internal beams maintain their shape over time, enabling the spa to hold its intended pressure and sturdiness. Made from a durable fabric material rather than PVC, they set the standard for internal stretch-resistance in the spa market.



## SPECIFICATIONS

WATER CAPACITY	1,190 L (314 gal.)
INFLATED SIZE	2.16 m x 71 cm (85" x 28")
INNER SIZE	1.66 m (65")
FILLED WEIGHT	1,225 kg (2,702 lbs)
RATING	220-240V~ 50Hz, 2050W at 20°C (68°F)
ACTUAL WATER FLOW	1,325 L/h (350 gal./h)
HEATING SYSTEM	Approx. 1.0-1.5°C/h (2-3°F/h)
CERTIFICATION	CE/GS
PACK/GROSS WEIGHT	1 Ea., 43.19 kg (95.22 lbs)

## FEATURES



FREEZE  
SHIELD™



AIRJET™  
MESSAGE SYSTEM



MULTI-FUNCTION  
PUMP



CAPACITY  
5-7 PEOPLE



1x  
MESSAGE  
REGULATION  
2 INTENSITY LEVELS



BESTWAY SMART  
HUB™ APP



LAY-Z-SPA.  
ST. MORITZ

## DIGITAL CONTROL PANEL





NEW  
GENERATION

# GRENADA SMART

60135

- Soothing AirJet™ bubble massage system (190 jets)
- Massage regulator provides 2 intensity level options
- Ultra-strong DuraPlus™ walls are stress-tested to offer durability
- MaxHold™ fabric internal beams provide superior air pressure retention, stability and lightweight portability
- Freeze Shield™ automatic heating prevents water from freezing & damaging the spa
- Program the spa heater up to 40 days in advance for future use
- Built-in Wi-Fi module, spa can be controlled through a phone app
- ChemConnect™ dispenser provides a stable level of chlorine throughout the spa
- Power-saving, timer-controlled heating system
- Digital control panel & spa pump with integrated filtration system includes cup holders and is accessible from inside the spa
- Reinforced cover with safety lock clips

## CONTENTS

- 1 spa
- 1 pool cover
- 1 spa pump
- 1 filter cartridge (VI)
- 1 ChemConnect™ dispenser
- 1 repair patch
- AirJet™ system



## DIMENSIONS

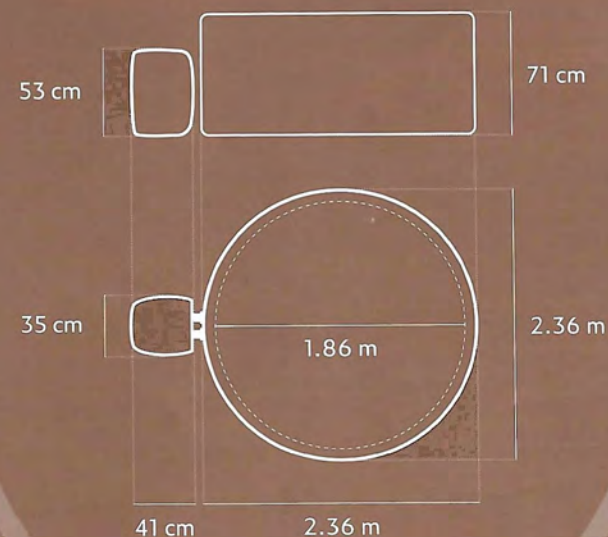

NEW  
GENERATION

# GRENADA SMART

60135

## DURAPLUS™ MATERIAL

### WALL AND TOP RING

The outer surface of this spa is constructed with premium DuraPlus™ material, providing superior durability, stretch resistance and structural stability.

## MAXHOLD™ MATERIAL

### INTERNAL BEAMS

MaxHold™ internal beams maintain their shape over time, enabling the spa to hold its intended pressure and sturdiness. Made from a durable fabric material rather than PVC, they set the standard for internal stretch-resistance in the spa market.

## SPECIFICATIONS

WATER CAPACITY	1,350 L (357 gal.)
INFLATED SIZE	2.36 m x 71 cm (93" x 28")
INNER SIZE	1.86 m (73")
FILLED WEIGHT	1,389 kg (3,062 lbs)
RATING	220-240V~ 50Hz, 2050W at 20°C (68°F)
ACTUAL WATER FLOW	1,325 L/h (350 gal./h)
HEATING SYSTEM	Approx. 1.0-1.5°C/h (2-3°F/h)
CERTIFICATION	CE/GS
PACK/GROSS WEIGHT	1 Ea., 48.01 kg (105.84 lbs)

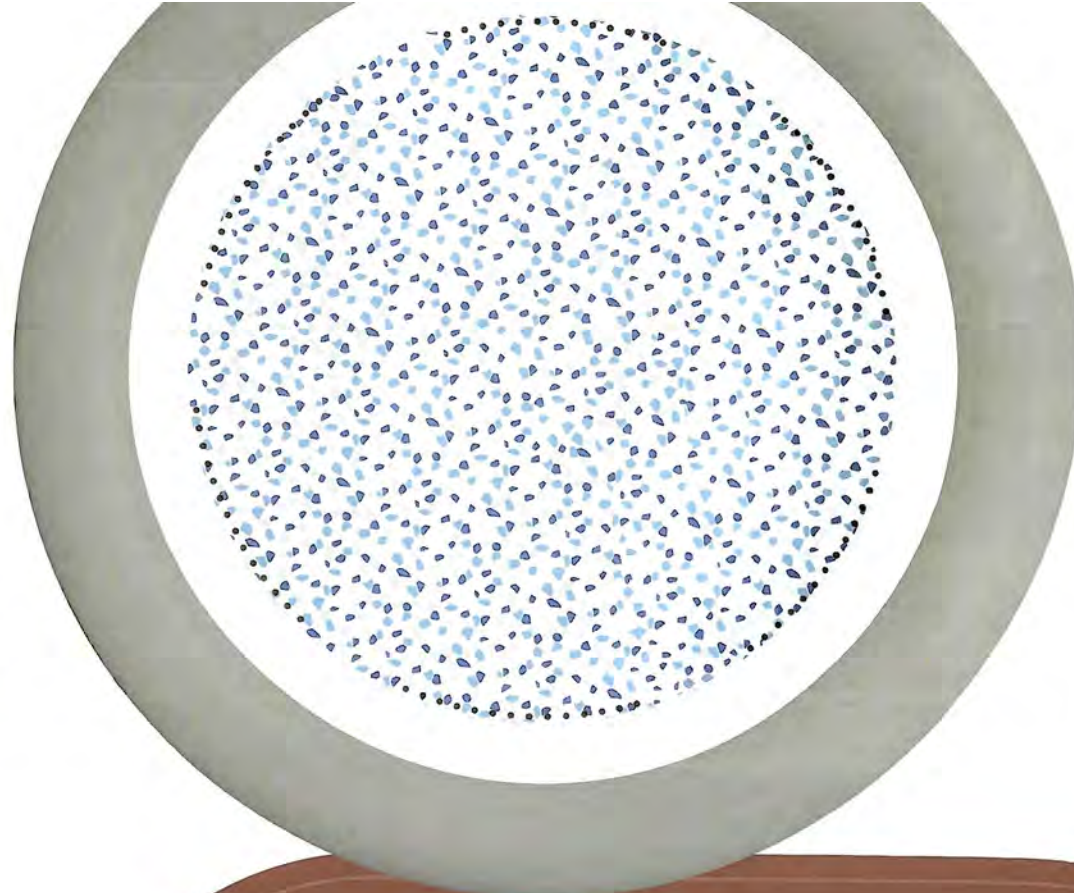

## FEATURES



FREEZE  
SHIELD™



AIRJET™  
MASSAGE SYSTEM



MULTI-FUNCTION  
PUMP



CAPACITY  
6-8 PEOPLE



1x  
MASSAGE  
REGULATION  
2x  
2 INTENSITY LEVELS



BESTWAY SMART  
HUB™ APP



## DIGITAL CONTROL PANEL







# AIRJET PLUS™ SYSTEM

## MASSAGING BUBBLES ARE THE PERFECT WAY TO UNWIND.

The AirJet Plus™ system releases bubbles from both the bottom and the sidewalls of the spa to target both the legs and back.

## FOOT MASSAGE

The AirJet Plus™ system features additional jets, strategically placed to provide a relaxing foot massage. By placing another circle of massage bubbles in the center of the spa, we are able to target the legs as well as the back of the user.





## MULTI-FUNCTION PUMP

The included spa pump is convenient and accessible, complete with a digital interface and cup holders. This pump inflates the spa, starts the heating and massage systems, and can activate the filtration system. The design also just received a convenient upgrade - spa users can now reach the digital interface from inside the spa. No standing or exiting needed!





## DIGITAL CONTROL PANEL

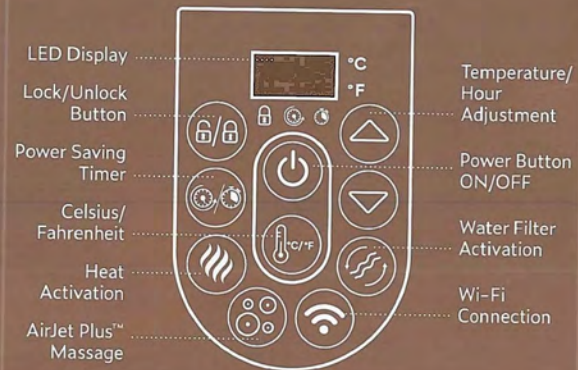

FORTIFIBER™ SERIES



NEW  
GENERATION

# MILAN SMART

60029

- Soothing AirJet Plus™ targeted bubble massage system (140 jets)
- Massage regulator provides 2 intensity level options
- Ultra-strong DuraPlus™ walls are stress-tested to offer durability
- MaxHold™ fabric internal beams provide superior air pressure retention, stability and lightweight portability
- Freeze Shield™ automatic heating prevents water from freezing & damaging the spa
- Program the spa heater up to 40 days in advance for future use
- Built-in Wi-Fi module, spa can be controlled through a phone app
- ChemConnect™ dispenser provides a stable level of chlorine throughout the spa
- Power-saving, timer-controlled heating system
- Digital control panel & spa pump with integrated filtration system includes cup holders and is accessible from inside the spa
- Reinforced cover with safety lock clips

## CONTENTS

- 1 spa
- 1 pool cover
- 1 spa pump
- 1 filter cartridge (VI)
- 1 ChemConnect™ dispenser
- 1 repair patch
- AirJet Plus™ system



## DIMENSIONS

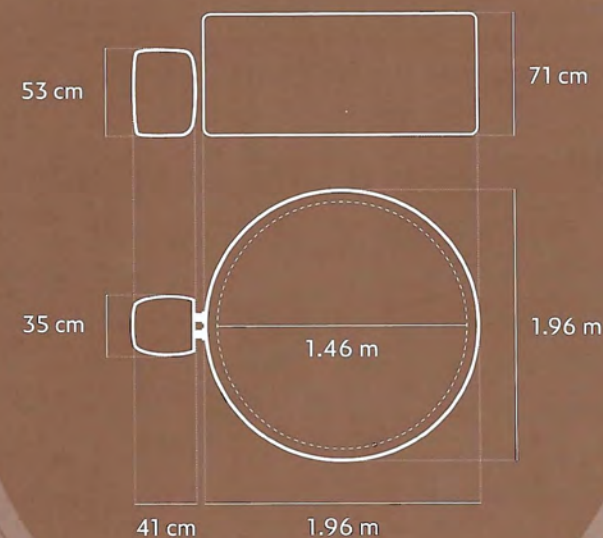

NEW  
GENERATION

# MILAN SMART

60029

## DURAPLUS™ MATERIAL

### WALL AND TOP RING

The outer surface of this spa is constructed with premium DuraPlus™ material, providing superior durability, stretch resistance and structural stability.



## MAXHOLD™ MATERIAL

### INTERNAL BEAMS

MaxHold™ internal beams maintain their shape over time, enabling the spa to hold its intended pressure and sturdiness. Made from a durable fabric material rather than PVC, they set the standard for internal stretch-resistance in the spa market.

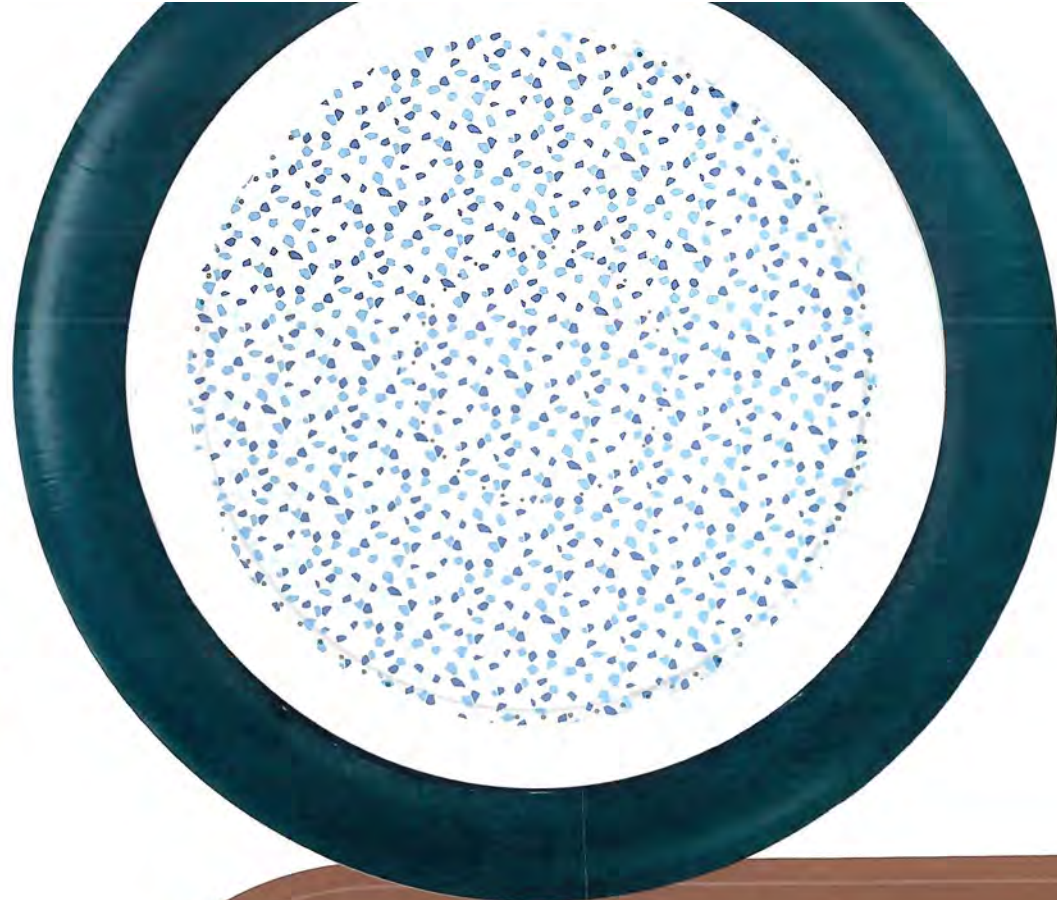

## SPECIFICATIONS

WATER CAPACITY	916 L (242 gal.)
INFLATED SIZE	1.96 m x 71 cm (77" x 28")
INNER SIZE	1.46 m (57")
FILLED WEIGHT	948 kg ( 2,089 lbs)
RATING	220-240V~ 50Hz, 2050W at 20°C (68°F)
ACTUAL WATER FLOW	1,325 L/h (350 gal./h)
HEATING SYSTEM	Approx. 1.5-2.0°C/h (3-4°F/h)
CERTIFICATION	CE/GS
PACK/GROSS WEIGHT	1 Ea., 38.67 kg (85.25 lbs)

## FEATURES



FREEZE  
SHIELD™



AIRJET PLUS™  
MESSAGE SYSTEM



MULTI-FUNCTION  
PUMP



CAPACITY  
4-6 PEOPLE



MESSAGE  
REGULATION  
2 INTENSITY LEVELS



BESTWAY SMART  
HUB™ APP

NEW  
GENERATION

# HELSINKI SMART

60025

- Soothing AirJet Plus™ bubble massage system (180 jets)
- Massage regulator provides 2 intensity level options
- Walls are made of FortiFiber™ material, providing a strong and durable hard-sided spa
- Freeze Shield™ automatic heating prevents water from freezing & damaging the spa
- Program the spa heater up to 40 days in advance for future use
- Built-in Wi-Fi module, spa can be controlled through a phone app
- ChemConnect™ dispenser provides a stable level of chlorine throughout the spa
- Power-saving, timer-controlled heating system
- Digital control panel & spa pump with integrated filtration system includes cup holders and is accessible from inside the spa
- Reinforced cover with safety lock clips

## CONTENTS

- 1 spa
- 1 pool cover
- 1 spa pump
- 1 filter cartridge (VI)
- 1 ChemConnect™ dispenser
- 1 high pressure hand pump
- 1 repair patch
- AirJet Plus™ system



## DIMENSIONS

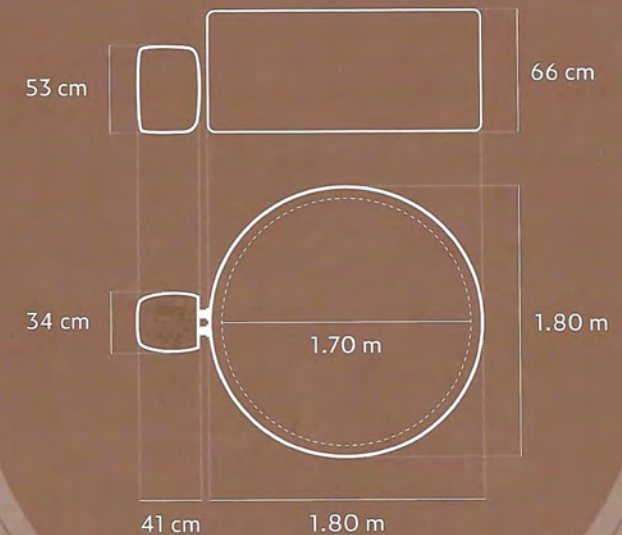



NEW  
GENERATION

# HELSINKI SMART

60025

## FORTIFIBER™ MATERIAL DROP STITCH STRENGTH & DURABILITY

The FortiFiber™ walls are constructed using thousands of fine threads to securely connect the internal walls, seal in air, and provide lightweight rigidity that is similar to a hard-sided spa.

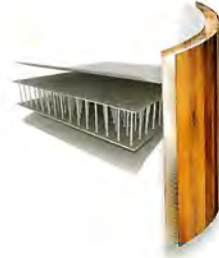

## SPECIFICATIONS

WATER CAPACITY	1,123 L (297 gal.)
INFLATED SIZE	1.80 m x 66 cm (71" x 26")
INNER SIZE	1.70 m (67")
FILLED WEIGHT	1,155 kg (2,548 lbs)
RATING	220-240V~ 50Hz, 2050W at 20°C (68°F)
ACTUAL WATER FLOW	1,325 L/h (350 gal./h)
HEATING SYSTEM	Approx. 1.0-1.5°C/h (2-3°F/h)
CERTIFICATION	CE/GS
PACK/GROSS WEIGHT	1 Ea., 40.13 kg (88.47 lbs)

## FEATURES



FREEZE  
SHIELD™



AIRJET PLUS™  
MASSAGE SYSTEM



MULTI-FUNCTION  
PUMP



CAPACITY  
5-7 PEOPLE



1x MASSAGE  
REGULATION  
2 INTENSITY LEVELS



BESTWAY SMART  
HUB™ APP

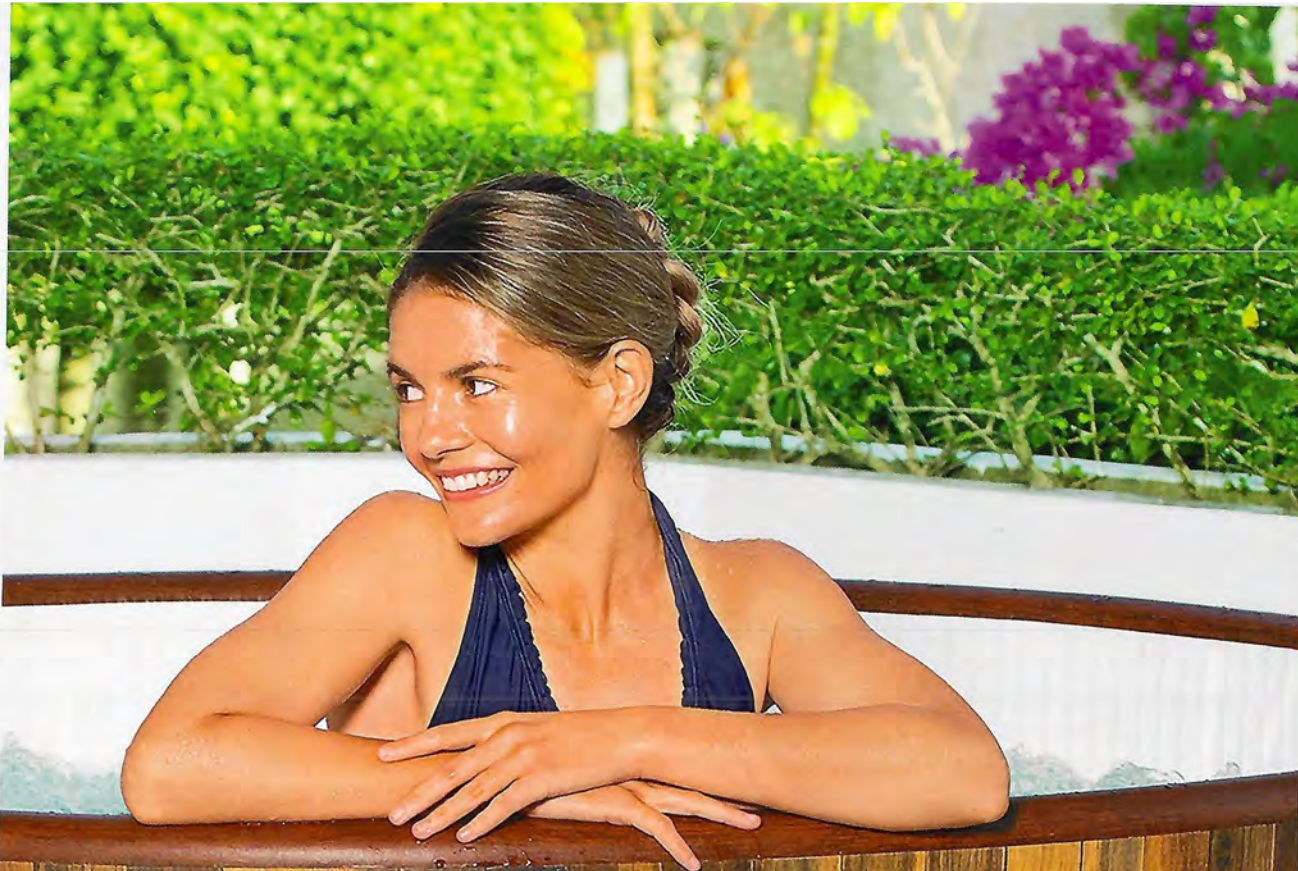

LAY-Z-SPA.  
HELSINKI

## DIGITAL CONTROL PANEL





# HYDROJET PRO™ SYSTEM

## PERFECT SPA RELAXATION AT YOUR FINGERTIPS.

HydroJet Pro™ is the best of both worlds!  
Adjustable nozzles along the inside walls of the  
spa release soothing jetstreams of water, while  
jets along the bottom release a calming flow of air  
bubbles specifically targeting your feet and back.





### FLOW CONTROL & DIRECTION

Pivot the nozzle to direct the jet wherever you wish. Twist the bezel to adjust the flow rate.

### AIRJET™ POSITIONING

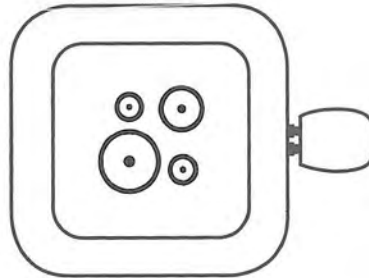

### HYDROJET™ POSITIONING

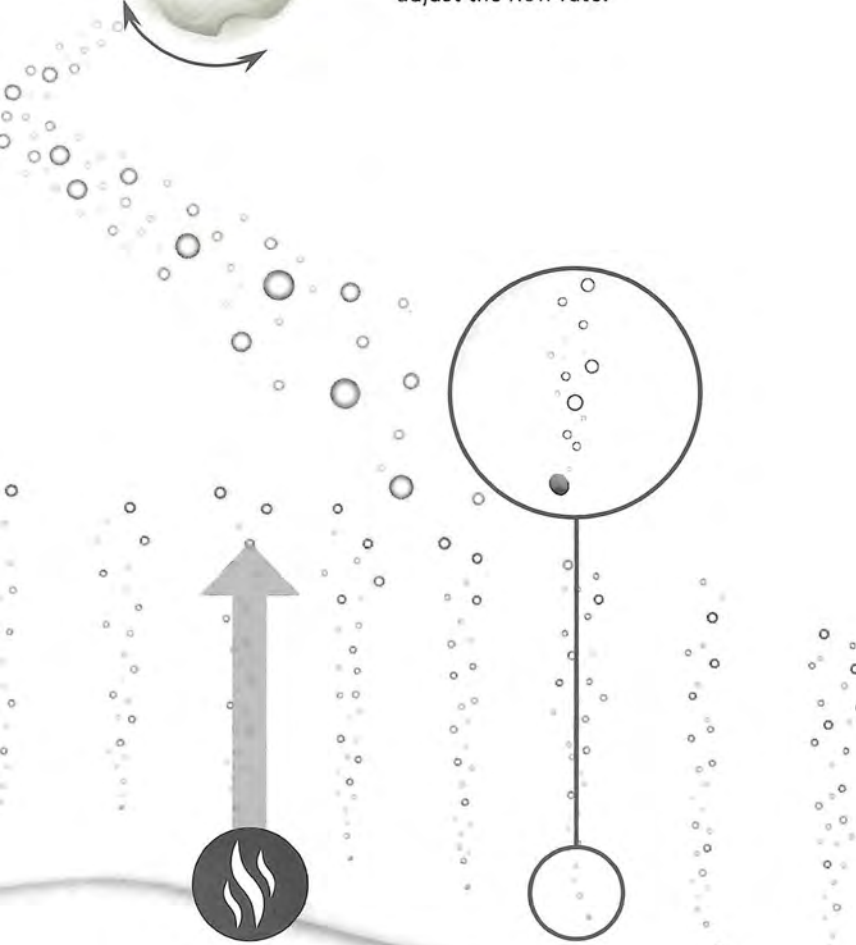
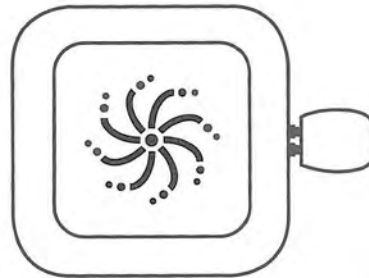

### COMBINATION HEAT & AIR MASSAGE



## MULTI-FUNCTION PUMP

The included spa pump is convenient and accessible, complete with a digital interface and cup holders. This pump inflates the spa, starts the heating and massage systems, and can activate the filtration system. The design also just received a convenient upgrade – spa users can now reach the digital interface from inside the spa. No standing or exiting needed!



LAY-Z-SPA.  
SANTORINI

NEW  
GENERATION

# SANTORINI SMART

60075

- Hydrodynamic water jetstream and air bubble massage system (10 jetstream nozzles and 180 jets)
- Massage regulator provides 2 intensity level options
- Ultra-strong DuraPlus™ walls are stress tested to offer durability
- MaxHold™ fabric internal beams provide superior air pressure retention, stability and lightweight portability
- Freeze Shield™ automatic heating prevents water from freezing & damaging the spa
- Program the spa heater up to 40 days in advance for future use
- Built-in Wi-Fi module, spa can be controlled through a phone app
- ChemConnect™ dispenser provides a stable level of chlorine throughout the spa
- ColorJet LED lights alternate between 7 different colors



- Power-saving, timer-controlled heating system
- Digital control panel & spa pump with integrated filtration system includes cup holders and is accessible from inside the spa
- Reinforced cover with safety lock clips
- Inflatable seat and padded pillows provide an ultra-comfortable experience

## CONTENTS

- 1 spa
- 1 pool cover
- 1 spa pump
- 1 filter cartridge (VI)
- 1 ChemConnect™ dispenser
- 5 pillows
- 2 water powered LED lights
- 1 repair patch
- HydroJet Pro™ system



## DIMENSIONS

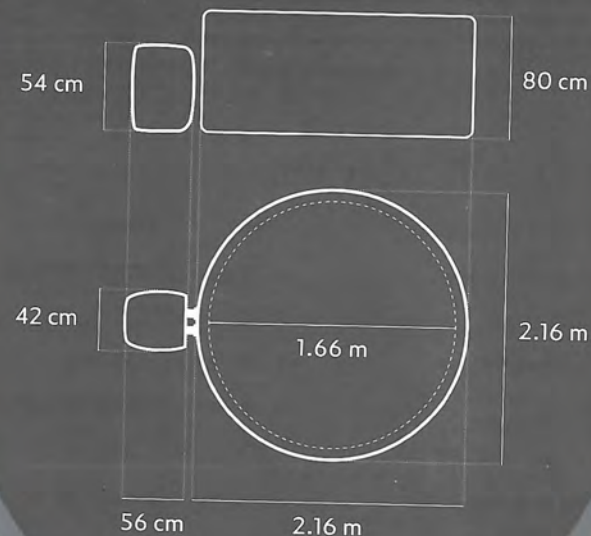

NEW  
GENERATION

# SANTORINI SMART

60075

## DURAPLUS™ MATERIAL

### WALL AND TOP RING

The outer surface of this spa is constructed with premium DuraPlus™ material, providing superior durability, stretch resistance and structural stability.



## MAXHOLD™ MATERIAL

### INTERNAL BEAMS

MaxHold™ internal beams maintain their shape over time, enabling the spa to hold its intended pressure and sturdiness. Made from a durable fabric material rather than PVC, they set the standard for internal stretch-resistance in the spa market.



## SPECIFICATIONS

WATER CAPACITY	1,190 L (314 gal.)
INFLATED SIZE	2.16 m x 80 cm (85" x 31.5")
INNER SIZE	1.66 m (65")
FILLED WEIGHT	1,251 kg (2,757 lbs)
RATING	220-240V~ 50Hz, 2050W at 20°C (68°F)
ACTUAL WATER FLOW	1,325 L/h (350 gal./h)
HEATING SYSTEM	Approx. 1.0-1.5°C/h (2-3°F/h)
CERTIFICATION	CE
PACK/GROSS WEIGHT	1 Ea., 73.43 kg (161.88 lbs)

## FEATURES



FREEZE  
SHIELD™



HYDROJET PRO™  
MASSAGE SYSTEM



MULTI-FUNCTION  
PUMP



CAPACITY  
5-7 PEOPLE



PADDED  
PILLOWS



7-COLOR  
LED LIGHTS



INTEGRATED  
SEATS



1x  
MASSAGE  
REGULATION  
2 INTENSITY LEVELS



BESTWAY SMART  
HUB™ APP



## DIGITAL CONTROL PANEL







NEW  
GENERATION

# MALDIVES SMART

60033

- Hydrodynamic water jetstream and air bubble massage system (8 jetstream nozzles and 180 jets)
  - Massage regulator provides 2 intensity level options
  - Ultra-strong DuraPlus™ walls are stress tested to offer durability
  - MaxHold™ fabric internal beams provide superior air pressure retention, stability and lightweight portability
  - Freeze Shield™ automatic heating prevents water from freezing & damaging the spa
  - Program the spa heater up to 40 days in advance for future use
  - Built-in Wi-Fi module, spa can be controlled through a phone app
  - ChemConnect™ dispenser provides a stable level of chlorine throughout the spa
  - ColorJet LED lights alternate between 7 different colors
- ● ● ● ● ● ●
- Power-saving, timer-controlled heating system
  - Digital control panel & spa pump with integrated filtration system includes cup holders and is accessible from inside the spa
  - Reinforced cover with safety lock clips
  - Inflatable seat and padded pillows provide an ultra-comfortable experience

## CONTENTS

- 1 spa
- 1 pool cover
- 1 spa pump
- 1 filter cartridge (VI)
- 1 ChemConnect™ dispenser
- 5 pillows
- 2 water powered LED lights
- 1 repair patch
- HydroJet Pro™ system



## DIMENSIONS

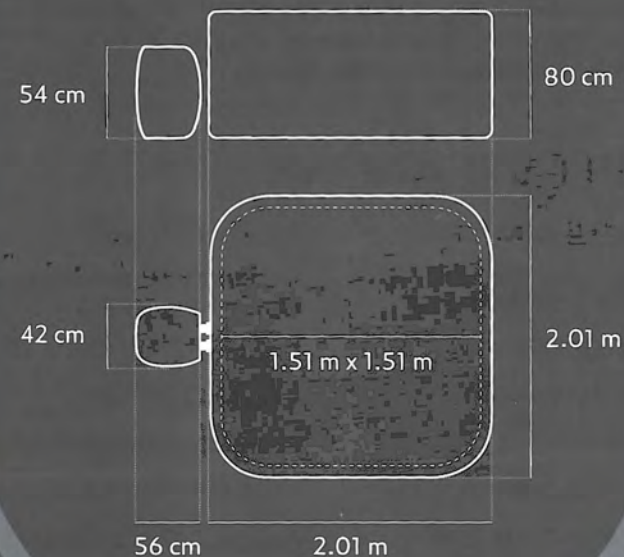

NEW  
GENERATION

# MALDIVES SMART

60033

## DURAPLUS™ MATERIAL

### WALL AND TOP RING

The outer surface of this spa is constructed with premium DuraPlus™ material, providing superior durability, stretch resistance and structural stability.



## MAXHOLD™ MATERIAL

### INTERNAL BEAMS

MaxHold™ internal beams maintain their shape over time, enabling the spa to hold its intended pressure and sturdiness. Made from a durable fabric material rather than PVC, they set the standard for internal stretch-resistance in the spa market.



## SPECIFICATIONS

WATER CAPACITY	1,050 L (277 gal.)
INFLATED SIZE	2.01 m x 2.01 m x 80 cm (79" x 79" x 31.5")
INNER SIZE	1.51 m x 1.51 m (59" x 59")
FILLED WEIGHT	1,115 kg (2,457 lbs)
RATING	220-240V~ 50Hz, 2050W at 20°C (68°F)
ACTUAL WATER FLOW	1,325 L/h (350 gal./h)
HEATING SYSTEM	Approx. 1.0-1.5°C/h (2-3°F/h)
CERTIFICATION	CE
PACK/GROSS WEIGHT	1 Ea., 78.47 kg (172.99 lbs)

## FEATURES



FREEZE  
SHIELD™



HYDROJET PRO™  
MASSAGE SYSTEM



MULTI-FUNCTION  
PUMP



CAPACITY  
5-7 PEOPLE



PADDED  
PILLOWS



7-COLOR  
LED LIGHTS



INTEGRATED  
SEATS



MASSAGE  
REGULATION  
2 INTENSITY LEVELS



BESTWAY SMART  
HUB™ APP



## DIGITAL CONTROL PANEL





NEW  
GENERATION

# SAN FRANCISCO SMART

60161

- Hydrodynamic water jetstream and air bubble massage system (10 jetstream nozzles and 180 jets)
- Jet massage nozzles integrated into the back of the lounge and leg massage integrated into the single lounge
- Massage regulator provides 2 intensity level options
- Ultra-strong DuraPlus™ walls are stress tested to offer durability
- MaxHold™ fabric internal beams provide superior air pressure retention, stability and lightweight portability
- Freeze Shield™ automatic heating prevents water from freezing & damaging the spa
- Program the spa heater up to 40 days in advance for future use
- Built-in Wi-Fi module, spa can be controlled through a phone app
- ChemConnect™ dispenser provides a stable level of chlorine throughout the spa
- ColorJet LED lights alternate between 7 different colors



- Power-saving, timer-controlled heating system
- Digital control panel & spa pump with integrated filtration system includes cup holders and is accessible from inside the spa
- Reinforced cover with safety lock clips
- Inflatable seats and padded pillows provide an ultra-comfortable experience

## CONTENTS

- 1 spa
- 1 pool cover
- 1 spa pump
- 1 filter cartridge (VI)
- 1 ChemConnect™ dispenser
- 5 pillows
- 2 water powered LED lights
- 1 repair patch
- HydroJet Pro™ system



## DIMENSIONS

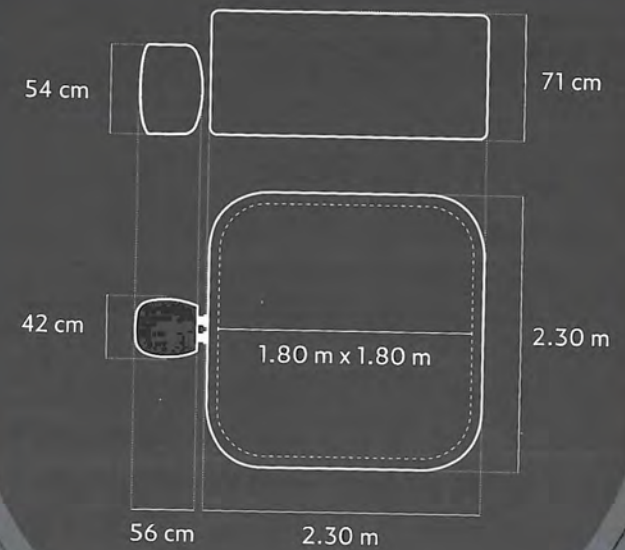

**NEW  
GENERATION**

# SAN FRANCISCO SMART

60161

## DURAPLUS™ MATERIAL

### WALL AND TOP RING

The outer surface of this spa is constructed with premium DuraPlus™ material, providing superior durability, stretch resistance and structural stability.



## MAXHOLD™ MATERIAL

### INTERNAL BEAMS

MaxHold™ internal beams maintain their shape over time, enabling the spa to hold its intended pressure and sturdiness. Made from a durable fabric material rather than PVC, they set the standard for internal stretch-resistance in the spa market.



## SPECIFICATIONS

WATER CAPACITY	1,180 L (312 gal.)
INFLATED SIZE	2.30 m x 2.30 m x 71 cm (90.5" x 90.5" x 28")
INNER SIZE	1.80 m x 1.80 m (71" x 71")
FILLED WEIGHT	1,256 kg (2,768 lbs)
RATING	220-240V~ 50Hz, 2050W at 20°C (68°F)
ACTUAL WATER FLOW	1,325 L/h (350 gal./h)
HEATING SYSTEM	Approx. 1.0-1.5°C/h (2-3°F/h)
CERTIFICATION	CE
PACK/GROSS WEIGHT	1 Ea., 91.68 kg (202.12 lbs)

## FEATURES



FREEZE SHIELD™



HYDROJET PRO™  
MASSAGE SYSTEM



MULTI-FUNCTION  
PUMP



CAPACITY  
5-7 PEOPLE



PADDED  
PILLOWS



7-COLOR  
LED LIGHTS



INTEGRATED  
SEATS



MASSAGE  
REGULATION  
2 INTENSITY LEVELS



BESTWAY SMART  
HUB™ APP



## DIGITAL CONTROL PANEL

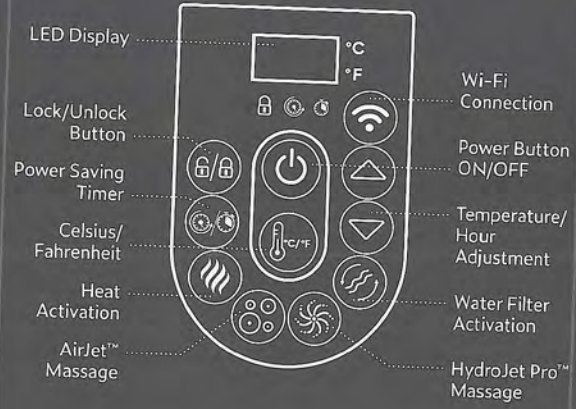



# XTRAS

## ACCESSORIES TO COMPLEMENT YOUR SPA.

Take the dirty work out of spa maintenance with the wide variety of accessory options that Bestway® offers.



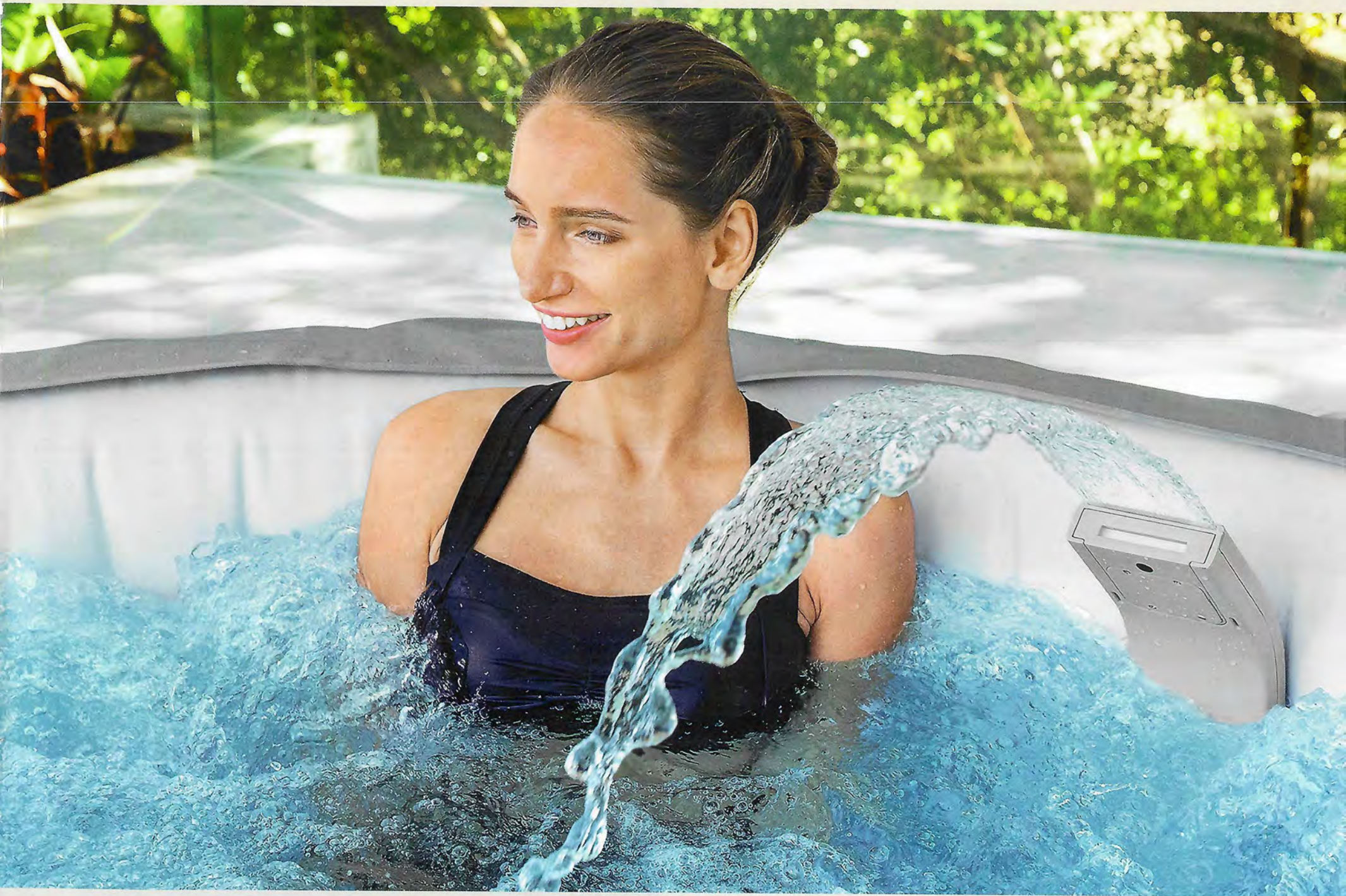

# UNDERWATER VACUUM

60323

- 1.50 m / 59"
- Compatible with Bestway AirJet™ & AirJet Plus™ spas
- Connects to the water outlets on the spa and uses the water flow to create suction
- Water Hose: 2.20 m / 86.6"
- Lightweight pole to easily maneuver the vacuum around the liner of the spa
- Features a brush head and reusable debris bag
- Full color box
- 6 Ea., 4.98 kg (10.98 lbs)

## CONTENTS

- 1 vacuum cleaner

**LIGHTWEIGHT POLE**  
for easy maneuverability

**WATER FLOW SUCTION**  
connects to water outlets in spa

**BRUSH HEAD**  
sweeps away dust and dirt

**REUSABLE DEBRIS BAG**  
collects leaves and other particles



NEW

# RECHARGEABLE UNDERWATER VACUUM

60327

- Rechargeable battery-powered pump creates suction, without the use of hoses or electrical cords
- Consistent performance for 50 minutes
- Charge time: 4-5 hours
- Simple press-button operation
- Ideal for spas and small pools
- Pivoting suction head with wheels and brushes
- Debris is collected in an easy-to-access and easy-to-empty stainless steel filter
- Full color box
- 4 Ea., 4.70 kg (10.36 lbs)

## CONTENTS

- 1 vacuum
- 1 USB charging cable

**TWO-SECTION POLE**  
with total reach of approximately  
1.55 m / 5.1'

**TRANSPARENT BODY**  
shows debris level

**RECHARGEABLE**  
plug, charge, and clean!

**PIVOTING SUCTION HEAD**



# PILLOW

60307

- 25 cm x 19.5 cm x 17.5 cm / 9.8" x 7.7" x 6.9"
- Soft pillow provides head and neck support
- Organic PU foam is 100% waterproof and resistant to chemicals and odors
- Compatible with all spas with a wall thickness between 20-27 cm (7.9"-10.6")
- Easy to clean
- Full color box
- 4 Sets., 3.67 kg (8.09 lbs)

## CONTENTS

- 2 pillows



# PADDED PILLOW

60316

- 23 cm x 13 cm x 5 cm / 9" x 5" x 2"
- Soft pillow provides head and neck support
- Adjustable strap drapes over the side of the spa, using the balance weight to keep it in place
- Compatible with all Lay-Z-Spas
- Comfortable sponge pillow is covered with washable mesh fabric
- Full color box
- 12 Sets., 4.16 kg (9.17 lbs)

## CONTENTS

- 2 pillows





## SPA SEAT

60321

- 40.8 cm x 31.5 cm x 20 cm / 16.06" x 12.40" x 7.87"
- Firm, sturdy spa seat is comfortable for hours of relaxation
- Seat legs can be adjusted to a custom height - from 8-12 cm (3.15"-4.72")
- Weighted seats will remain at the bottom of the spa
- Full color box
- 2 Ea., 5.49 kg (12.10 lbs)

### CONTENTS

- 1 seat





## SOOTHING LED WATERFALL

60322

- 46 cm x 17 cm x 10.4 cm / 18.11" x 6.69" x 4.09"
- Compatible with Bestway AirJet™ & AirJet Plus™ spas
- LED light alternates between 7 colors
- IP66 waterproof rating - protects from powerful streams of water and dust
- 2 hours of run time with auto-shutoff feature
- Magnetic attachment system for easy setup
- One-touch operation: simply press bottom button
- Uses 3 AAA batteries (not included)
- Full color box
- 4 Ea., 3.84 kg (8.47 lbs)

### CONTENTS

- 1 LED waterfall



# DRINK HOLDER

60306

- 35 cm x 23.2 cm x 20.5 cm / 13.8" x 9.1" x 8.1"
- Keep beverages or snacks close by while you relax
- Position anywhere on the top of spa sidewall
- Compatible with all spas with a wall thickness between 20-27 cm (7.9"-10.6")
- Full color box
- 12 Ea., 8.95 kg (19.73 lbs)

## CONTENTS

- 2 drink holders
- 1 tray



# 7-COLOR LED LIGHT

60303

- 9.2 cm x 6.2 cm / 3.6" x 2.4"
- Uses 3 AAA batteries (not included)
- IP68 waterproof
- LED light alternates between 7 colors
- 2 hours of run time with auto-shutoff feature
- One-touch operation: simply press top button
- Full color box
- 6 Ea., 0.98 kg (2.16 lbs)



## CONTENTS

- 1 7-Color LED Light

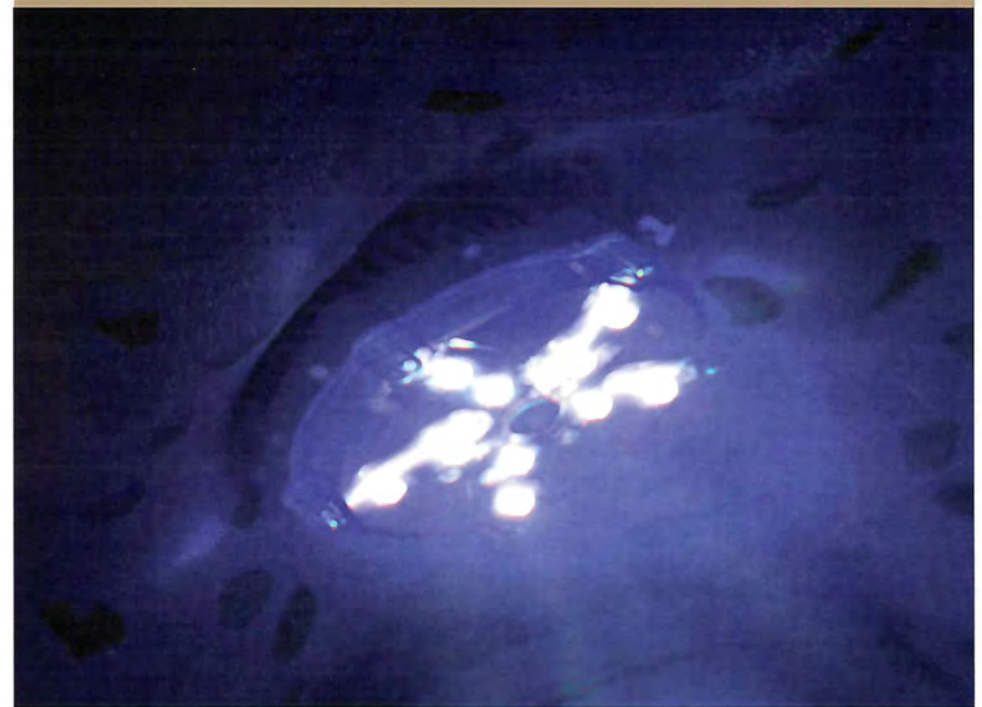





# DOME

60305

- 3.90 m x 3.90 m x 2.55 m / 12'9" x 12'9" x 8'4"
- Fabric with UV protection
- Fits all Bestway spas
- 4 large inside pockets to store personal items
- 4 detachable fabric and mesh doors, suitable for both winter and summer
- Suitable as a gazebo for use in the garden or backyard
- Can be used for pools up to 3.66 m (12") diameter
- Setup time: 15 min.
- Full color box
- 2 Ea., 34.36 kg (75.75 lbs)

## CONTENTS

- 1 tent
- 4 detachable fabric doors
- 4 detachable mesh doors
- 1 carry bag

# CANOPY

60304

- 1.83 m x 94 cm x 1.09 m / 6' x 37" x 43"
- Fabric with UV protection
- Compatible with all Bestway spas sized 1.80–2.70 m (71"–8'11")
- High density, ventilated mesh windows
- Two removable guy lines to provide stability
- Full color box
- 3 Ea., 4.09 kg (9.02 lbs)

## CONTENTS

- 1 tent
- 3 poles
- 2 guy lines
- 1 storage bag



NEW

# FLOOR PROTECTOR

60334

- 1.96 m x 1.96 m / 77" x 77"
- Compatible with all spas, multiple sets may be needed for spas larger than 1.96 m x 1.96 m (77" x 77")
- Durable polyethylene material that provides protection under the spa
- Includes additional 46.4 cm x 36.3 cm (18.3" x 14.3") mat for under the spa heater
- Attachable pieces for straight edges
- Shrink wrapped with insert card
- 4 Ea., 10.01 kg (22.07 lbs)

## CONTENTS

- 17 connectable protector pieces



# ALL IN ONE TOOL SET

60310

- Full color box
- 8 Ea., 7.30 kg (16.09 lbs)

## CONTENTS

- 1 scoop
- 1 brush
- 1 scrubbing mitt

### 1. SCOOP

- Bumper protects spa surface
- Rounded shape design fits the contours of the spa interior
- Deep net to collect debris
- Handheld or connects to standard telescopic pole

### 2. SCRUBBING MITT

- Scrub along spa water line
- Latex glove bonded with scrubber pad

### 3. BRUSH

- Bumper and nylon bristles protect spa's surface
- Handheld or connects to standard telescopic pole



# FILTER CARTRIDGE(VI) 60311

- 10.6 cm x 8.0 cm / 4.2" x 3.1"
- Easy to clean
- Shrink wrapped with insert card
- 12 Sets., 2.79 kg (6.15 lbs)

## CONTENTS

- 2 filter cartridges



# POOL & SPA TEST STRIPS 58142

- 4 cm x 9.5 cm / 1.5" x 3.75"
- 3-in-1 test strips use an instant color-match system to measure free chlorine (0-10 ppm), pH (6.2-8.4) & total alkalinity (0-240 ppm)
- 18-month shelf life
- Full color box
- 24 Ea., 1.37 kg (3.02 lbs)

## CONTENTS

- 50 test strips



# TECHNICAL FEATURES & ACCESSORY COMPATIBILITY



	ST. LUCIA 60037	MIAMI 60001	BAHAMAS SIGNATURE 60005	FIJI SIGNATURE 60085	HAVANA SMART 60035	BORACAY SMART 60175	IBIZA 60015	HOLLYWOOD LUXE 60059	HAWAII SMART 60261
STANDARD BEAM	▪	▪	▪	▪	▪	▪	▪	▪	▪
MAXHOLD™ BEAM									
FORTIFIBER™									
POWER SAVING TIMER	▪	▪	▪	▪	▪	▪	▪	▪	▪
WATER FILTER ACTIVATION	▪	▪	▪	▪	▪	▪	▪	▪	▪
HEATING SYSTEM	▪	▪	▪	▪	▪	▪	▪	▪	▪
LED LIGHTS							▪	▪	▪
APP REMOTE CONTROL					▪	▪			▪
UNDERWATER VACUUM 60323	▪	▪	▪	▪	▪	▪	▪	▪	▪
RECHARGEABLE UNDERWATER VACUUM 60327	▪	▪	▪	▪	▪	▪	▪	▪	▪
PILLOW 60307	▪	▪	▪	▪	▪	▪	▪	▪	▪
PADDED PILLOW 60316	▪	▪	▪	▪	▪	▪	▪	▪	▪
SPA SEAT 60321	▪	▪	▪	▪	▪	▪	▪	▪	▪
DRINK HOLDER 60306	▪	▪	▪	▪	▪	▪	▪	▪	▪
SOOTHING LED WATERFALL 60322	▪	▪	▪	▪	▪	▪	▪	▪	▪
7-COLOR LED LIGHT 60303	▪	▪	▪	▪	▪	▪	▪	▪	▪
DOME 60305	▪	▪	▪	▪	▪	▪	▪	▪	▪
CANOPY 60304		▪	▪	▪	▪	▪	▪	▪	▪
ALL IN ONE TOOL SET 60310	▪	▪	▪	▪	▪	▪	▪	▪	▪
POOL & SPA TEST STRIPS 58142	▪	▪	▪	▪	▪	▪	▪	▪	▪
FILTER CARTRIDGE(VI) 60311	▪	▪	▪	▪	▪	▪	▪	▪	▪
FLOOR PROTECTOR 60334	▪	▪	▪	▪	▪	▪	▪	▪	▪



ZÜRICH ENERGYSENSE™ 60065	BUDAPEST ENERGYSENSE™ 60179	HONOLULU SMART 60019	HAWAII SMART 60021	ST. MORITZ SMART 60023	GRENADA SMART 60135	MILAN SMART 60029	HELSINKI SMART 60025	SANTORINI SMART 60075	MALDIVES SMART 60033	SAN FRANCISCO SMART 60161
*	*	*	*	*	*	*	*	*	*	*
*	*	*	*	*	*	*	*	*	*	*
*	*	*	*	*	*	*	*	*	*	*
*	*	*	*	*	*	*	*	*	*	*
*	*	*	*	*	*	*	*	*	*	*
*	*	*	*	*	*	*	*	*	*	*
*	*	*	*	*	*	*	*	*	*	*
*	*	*	*	*	*	*	*	*	*	*
*	*	*	*	*	*	*	*	*	*	*
*	*	*	*	*	*	*	*	*	*	*
*	*	*	*	*	*	*	*	*	*	*
*	*	*	*	*	*	*	*	*	*	*
*	*	*	*	*	*	*	*	*	*	*
*	*	*	*	*	*	*	*	*	*	*
*	*	*	*	*	*	*	*	*	*	*
*	*	*	*	*	*	*	*	*	*	*
*	*	*	*	*	*	*	*	*	*	*
*	*	*	*	*	*	*	*	*	*	*
*	*	*	*	*	*	*	*	*	*	*
*	*	*	*	X2	X2	*	*	X2	X2	X2

# SETUP & MAINTENANCE

WITH THE KEY TOOLS ALREADY INCLUDED, LAY-Z-SPA SETUP IS QUICK & EASY!

After finding a flat area for the spa, it's as easy as 1, 2, 3!

1. INFLATE the spa with the multi-function pump.
2. CONNECT the pump to the spa, and ensure all of the tubes are attached to the correct openings.
3. FILL the spa with water to the indicated level, and enjoy!

Also included with each spa is a chemical dispenser and filter cartridge to keep the water sparkling. Maintaining clean and healthy spa water is important for the user's experience, and also extends the longevity of the spa.

Thanks to a new function available on all spas, the pump can also quickly and conveniently deflate the spa for transport or storage.







# INDEX

AIRJET™



ST. LUCIA  
60037  
pg 26-29



MIAMI  
60001  
pg 30-33



BAHAMAS  
SIGNATURE  
60005  
pg 34-37



FIJI  
SIGNATURE  
60085  
pg 38-41

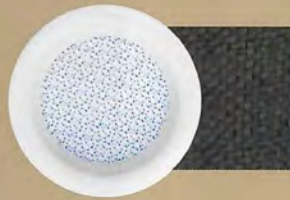

HAVANA  
SMART  
60035  
pg 42-45



BORACAY  
SMART  
60175  
pg 46-49



IBIZA  
60015  
pg 50-53



HOLLYWOOD  
LUXE  
60059  
pg 54-57

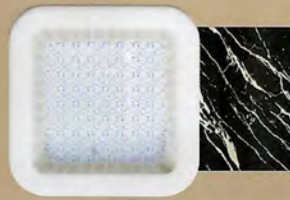

HAWAII  
SMART  
60261  
pg 58-61



ZURICH  
ENERGYSense™  
60065  
pg 62-65

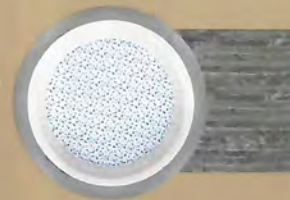

BUDAPEST  
ENERGYSense™  
60179  
pg 66-69

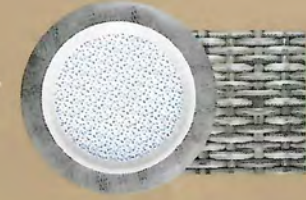

HONOLULU  
SMART  
60019  
pg 70-73



HAWAII  
SMART  
60021  
pg 74-77



ST. MORITZ  
SMART  
60023  
pg 78-81



GRENADA  
SMART  
60135  
pg 82-85

 AIRJET PLUS™



MILAN  
SMART  
60029  
pg 88-91



HELSINKI  
SMART  
60025  
pg 92-95

 HYDROJET PRO™

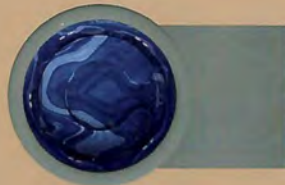

SANTORINI  
SMART  
60075  
pg 98-101



MALDIVES  
SMART  
60033  
pg 102-105



SAN FRANCISCO  
SMART  
60161  
pg 106-109

XTRAS



UNDERWATER  
VACUUM  
60323 | pg 112



RECHARGEABLE  
UNDERWATER  
VACUUM  
60327 | pg 113



PILLOW  
60307 | pg 114



PADDED  
PILLOW  
60316 | pg 114



SPA SEAT  
60321 | pg 115



SOOTHING LED  
WATERFALL  
60322 | pg 116



DRINK HOLDER  
60306 | pg 117



7-COLOR LED  
LIGHT  
60303 | pg 117



DOME  
60305 | pg 118



CANOPY  
60304 | pg 119



FLOOR  
PROTECTOR  
60334 | pg 119



ALL IN ONE  
TOOL SET  
60310 | pg 120



FILTER  
CARTRIDGE (VI)  
60311 | pg 121



POOL & SPA  
TEST STRIPS  
58142 | pg 121

# LAY-Z-SPA® 2024

## SHANGHAI

Bestway Inflatables & Material Corp.  
No. 208 Jin Yuan Wu Road,  
Shanghai, 201812, China  
Tel: +86 21 6913 5588  
E-mail: info@bestwaycorp.com

## HONG KONG

Bestway (Hong Kong) International Ltd.  
Suite 713, 7/Floor, East Wing, Tsim Sha Tsui Centre,  
66 Mody Road, Kowloon, Hong Kong  
Tel: +852 2997 7169  
E-mail: info@bestwaycorp.hk

## U.S.A.

Bestway (USA) Inc.  
3435 S. McQueen Road, Chandler,  
AZ 85286, United States of America  
Tel: +1 480 838 3888  
E-mail: info@bestwaycorp.us

## EUROPE

Bestway Europe S.p.a.  
Via Resistenza, 5  
20098 San Giuliano M.se (Mi), Italy  
Tel: +39 02 9884 881  
E-mail: info@bestwaycorp.eu

## EASTERN EUROPE

Bestway Eastern Europe Sp. z o.o.  
Ul. Ekologiczna 24  
05-080 Kludyn Poland  
Tel: +48 22 60 22 508  
E-mail: info@bestwaycorp.pl

## LATIN AMERICA

Bestway Central & South America Ltda  
Salar Ascotan 1282, Parque Enea,  
Pudahuel, Santiago, Chile  
Tel: +562 3203 6438  
E-mail: info@bestwaycorp.lat

## BRAZIL

Bestway Brazil  
Av Cerro Azul, 2783 Maringá - PR - Brazil  
Zip Code: 87010-055  
Tel: +55 44 3046 2950 / +0800 001 8400  
E-mail: info@bestwaycorp.com.br

## AUSTRALIA

Bestway Australia Pty Limited  
Unit 2/98-104 Carnarvon St  
Silverwater, NSW 2128, Australia  
Tel: +61 2 9037 1388  
E-mail: info@bestwaycorp.com.au

## FRANCE

Bestway France Sarl  
1681 route des Dolines - Les Taissounières - Belem  
06560 VALBONNE  
Tel: +33 4 97 04 92 99  
E-mail: info@bestwaycorp.fr

## GERMANY

Bestway Deutschland GmbH  
Parkstraße 11  
24534 Neumünster, Germany  
Tel: +49 4321 555 05 - 0  
E-mail: info@bestwaycorp.de

## SCANDINAVIA

Bestway Scandinavia A/S  
Amagervej 17, 3<sup>rd</sup> Fl  
DK-1160 Copenhagen K Denmark  
Tel: +45 78744569  
E-mail: info@bestwayscandinavia.eu

**Bestway**

[WWW.BESTWAYCORP.COM](http://WWW.BESTWAYCORP.COM)



©2023 Bestway Inflatables & Material Corp. All rights reserved.

® ™ Trademarks owned and managed by Bestway Inflatables & Material Corp.